

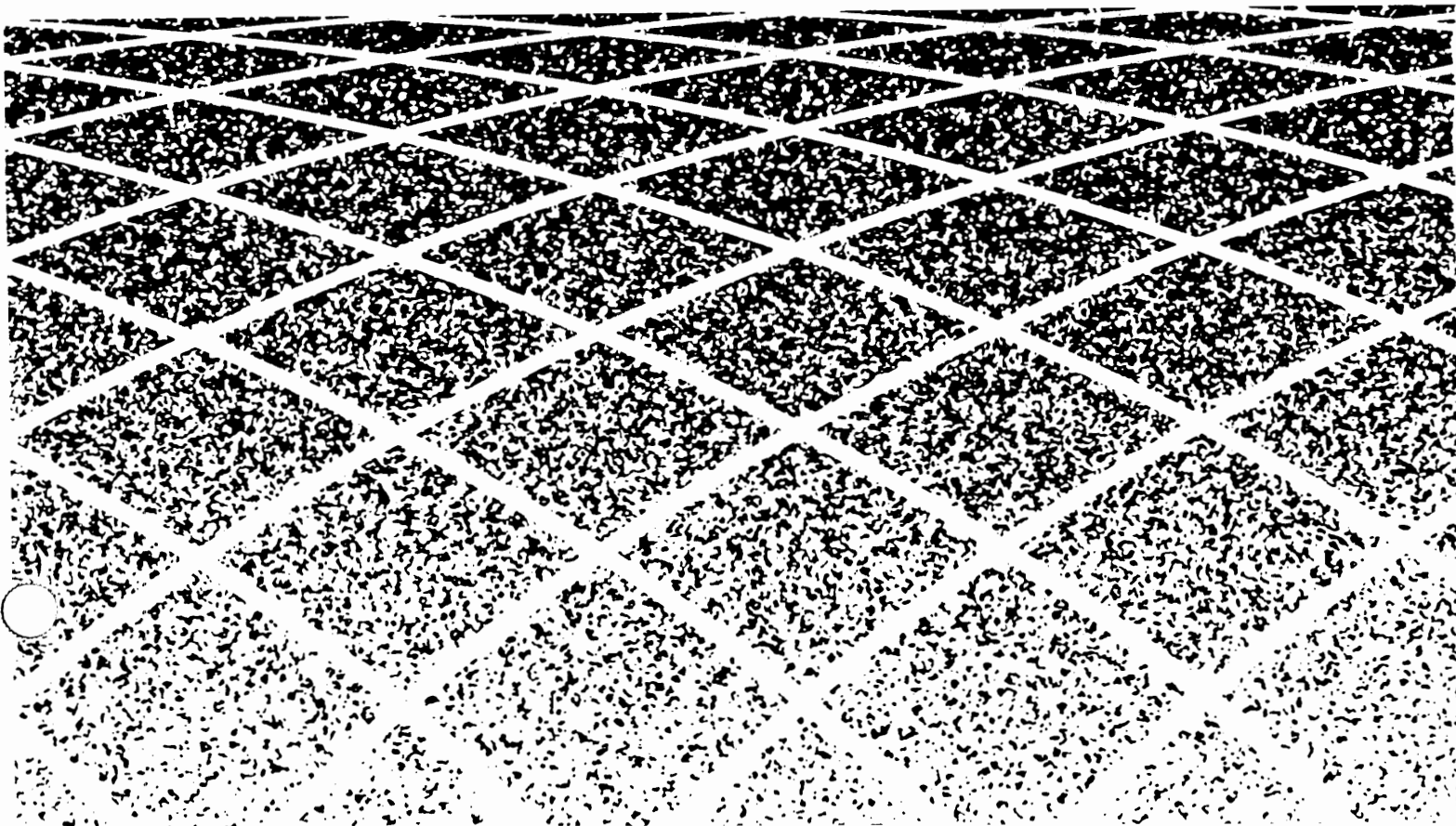

**UNIX® System V  
AT&T C++ Language System  
Release 2.0**

**Selected Readings  
Select Code 307-144**



**© 1989 AT&T**  
**All Rights Reserved**  
**Printed In USA**

**NOTICE**

The information in this document is subject to change without notice. AT&T assumes no responsibility for any errors that may appear in this document.

Amdahl is a registered trademark of Amdahl Corporation.  
DEC is a registered trademark of Digital Equipment Corporation.  
IBM is a registered trademark of International Business Machines.  
Intel is a registered trademark of Intel Corporation.  
Motorola MC68000 is a trademark of Motorola Inc.  
MS and MS-DOS are registered trademarks of Microsoft Corporation.  
UNIX is a registered trademark of AT&T.  
VAX is a registered trademark of Digital Equipment Corporation.  
VMS is a trademark of Digital Equipment Corporation.

---

# Contents

---

---

## Preface

Preface	i
Acknowledgements	ii

---

<b>1</b>	<b>Evolution of C++</b>	
	The Evolution of C++: 1985 to 1989	1-1
	Footnotes	1-49

---

<b>2</b>	<b>An Introduction to C++</b>	
	An Introduction to C++	2-1
	A C++ Example	2-3
	The Specification	2-7
	The Implementation	2-15
	Other Uses for Abstract Data Types	2-26
	Object-Oriented Programming in C++	2-28
	The Current Status of C++	2-36
	The Future of C++	2-37
	Footnotes	2-38

---

<b>3</b>	<b>An Overview of C++</b>	
	An Overview of C++	3-1
	Footnotes	3-16

---

<b>4</b>	<b>Object-Oriented Programming</b>	
	What is "Object-Oriented Programming"?	4-1
	Footnotes	4-25

---

<b>5</b>	<b>Multiple Inheritance</b>	
	Multiple Inheritance for C++	5-1
	Footnotes	5-20

---

<b>6</b>	<b>Type-Safe Linkage for C++</b>	
	Type-safe Linkage for C++	6-1
	Footnotes	6-23

---

**7**      **Access Rules for C++**  
Access Rules for C++  
Footnotes

7-1  
7-12

---

**A**      **Appendix A**  
Manual Pages for C++ Language System

A-1

---

**I**      **Index**  
Index

I-1



---

# Figures and Tables

---

<b>Figure 1-1:</b> A Directed Acyclic Graph	1-17
<b>Figure 2-1:</b> The Heritage of C++	2-1
<b>Figure 2-2:</b> An Abstract Data Type	2-4
<b>Figure 2-3:</b> Combining the specification (BigInt.h) and implementation (BigInt.c) of an abstract data type (BigInt) with the source code of a client program (client.c) to produce an executable program(client).	2-6
<b>Figure 2-4:</b> A diagram of the BigInt data structure for the number 654321	2-8
<b>Figure 2-5:</b> Client programs can access the private member variables of an instance of a class only by calling public member functions of the class.	2-9
<b>Figure 2-6:</b> Organization of Classes for a Graphics Package	2-29
<b>Figure 2-7:</b> Improved Organization of Classes for a Graphics Package	2-31
<b>Figure 2-8:</b> The data structure of a simple picture. Instances of OOPS library classes are shown as dashed rectangles.	2-34
<b>Figure 7-1:</b> Derivation Relationship	7-4



---

**Preface**

---

**Preface**

i

---

**Acknowledgements**

ii

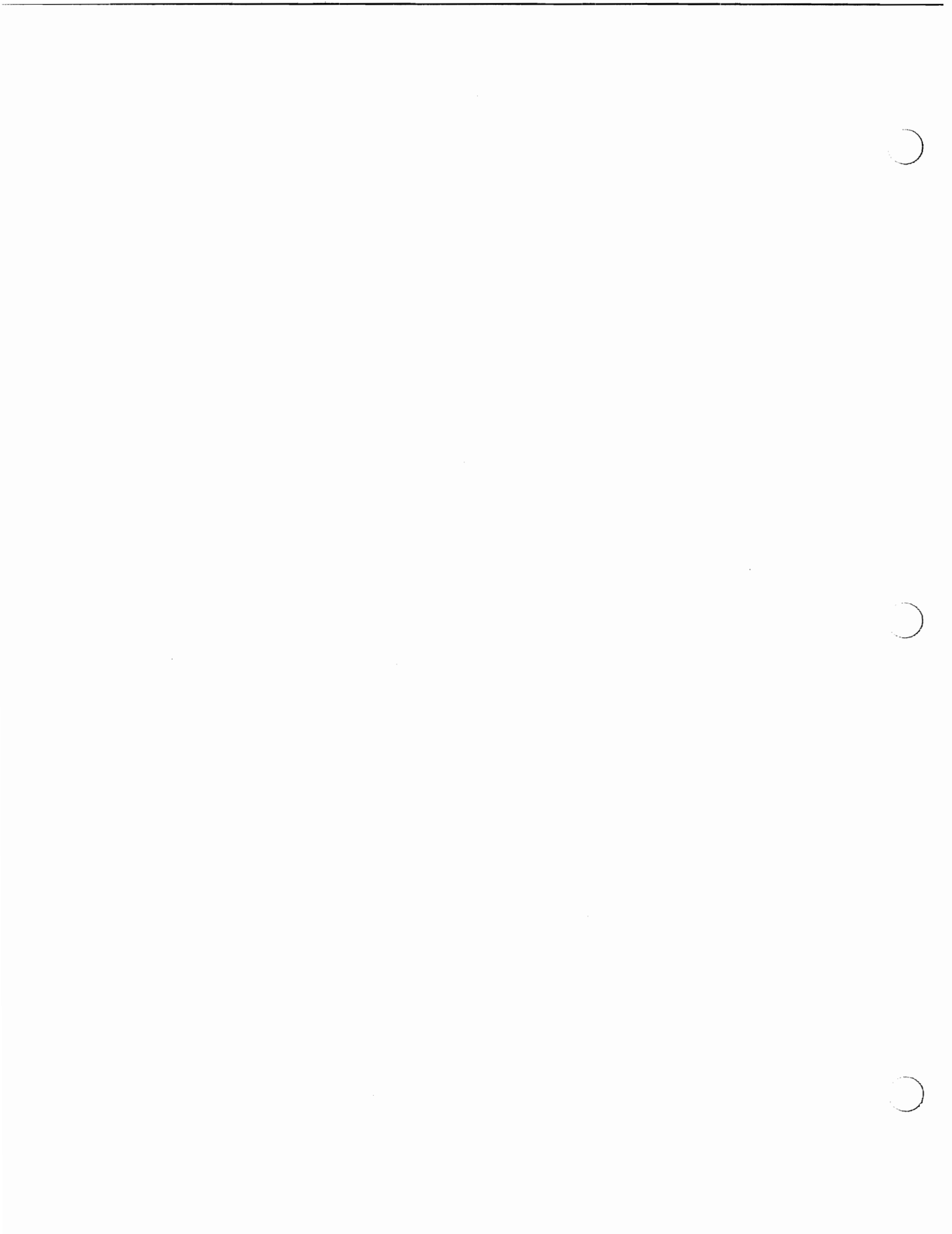

---

## Preface

The *AT&T C++ Language System Selected Readings* contains papers about the C++ language. The manual is part of a set of four documents that are supplied with your C++ Language System. The other documents are:

- the *Release Notes*, which describe the contents of this release, how to install it, and changes to the language
- the *Product Reference Manual*, which provides a complete definition of the C++ language supported by the Release 2.0 C++ Language System
- the *Library Manual*, which describes the three C++ class libraries and tells you how to use them

The seven chapters in this manual are based on technical memoranda by authors working with various aspects of the C++ language. These chapters cover features of the language provided by Release 2.0 of the translator.

- Chapter 1 lists the new features of C++ and describes each one briefly
- Chapter 2 is a tutorial showing you how to use the special features that C++ provides
- Chapter 3 is an overview of the language provided with Release 2.0
- Chapter 4 describes support for object-oriented programming in C++
- Chapter 5 explains the new multiple inheritance feature and describes its use
- Chapter 6 explains the new type-safe linkage capabilities
- Chapter 7 explains levels of protection in C++ class definitions
- Appendix A contains the manual pages for the C++ Language System, including the `CC`, `c++filt`, and `demangle` commands

To make the best use of the *Selected Readings*, you should be familiar with the C programming language and the C programming environment under the UNIX® operating system. Refer to Appendix B of the *Release Notes* for further sources of information about these topics.

---

## Acknowledgements

- Chapter 1 is based on the paper, "The Evolution of C++; 1985 to 1989," by Bjarne Stroustrup. That paper acknowledges the following contributions:

Most of the credit for these extensions goes to the literally hundreds of C++ users who provided me with bugs, mistakes, suggestions, and most importantly with sample problems.

Phil Brown, Tom Cargill, Jim Coplien, Steve Dewhurst, Keith Gorlen, Laura Eaves, Bob Kelley, Brian Kernighan, Andy Koenig, Archie Lachner, Stan Lippman, Larry Mayka, Doug McIlroy, Pat Philip, Dave Prosser, Peggy Quinn, Roger Scott, Jerry Schwarz, Jonathan Shopiro, and Kathy Stark supplied many valuable suggestions and questions.

The C++ multiple inheritance mechanism was partially inspired by the work of Stein Krogdahl from the University of Oslo.

- Chapter 2 is based on the paper, "An Introduction to C++," by Keith Gorlen.
- Chapter 3 is based on the paper, "An Overview of C++," by Bjarne Stroustrup, published in *ACM Sigplan Notices*, October 1986, pp. 7-18. That paper acknowledges the following contributions:

C++ could never have matured without the constant help and constructive criticism of my colleagues and users; notably Tom Cargill, Jim Coplein, Stu Feldman, Sandy Fraser, Steve Johnson, Brian Kernighan, Bart Locanthi, Doug McIlroy, Dennis Ritchie, Ravi Sethi, and Jon Shopiro. Brian Kernighan and Andy Koenig made many helpful comments on drafts of this paper.

- Chapter 4 is based on the paper, "What is Object-Oriented Programming," by Bjarne Stroustrup, published in *IEEE Software Magazine*, May 1988, pp. 10-20. That paper acknowledges the following contributions:

An earlier version of this paper was presented to the Association of Simula Users meeting in Stockholm. The discussions there caused many improvements both in style and content. Brian Kernighan and Ravi Sethi made many constructive comments. Also thanks to all who helped shape C++.

- Chapter 5 is based on the paper, "Multiple Inheritance for C++," by Bjarne Stroustrup, published in the proceedings of the EUUG Spring Conference, May 1987 (revised for this manual). That paper acknowledges the following contributions:

In 1984 I had a long discussion with Stein Krogdahl from the University of Oslo, Norway. He had devised a scheme for implementing multiple inheritance in Simula using pointer manipulation based on addition and subtraction of constants. His paper, "An Efficient Implementation of Simula Classes with Multiple Prefixing" (Research Report No. 83, June 1984, University of Oslo, Institute of Informatics) describes this work. Tom Cargill, Jim Coplien, Brian Kernighan, Andy Koenig, Larry Mayka, Doug McIlroy, and Jonathan Shopiro supplied many valuable suggestions and questions.

- Chapter 6 is based on the paper, "Type-Safe Linkage for C++," by Bjarne Stroustrup, published in *Computing Systems*, Volume VI, no. 4, Fall 1988, pp. 371-404. That paper acknowledges the following contributions:

The new linkage and overloading scheme was essentially a joint effort of Andrew Koenig, Doug McIlroy, Jerry Schwarz, Jonathan Shopiro, and me. Brian Kernighan made many useful comments. The name encoding scheme is based on a proposal by Stan Lippman and Steve Dewhurst with input from Andrew Koenig and me. Steve Dewhurst, Bill Hopkins, Jim Howard, Mike Mowbray, Tim O'Konski, and Roger Scott also made valuable comments on earlier versions on this paper.

- Chapter 7 is based on the paper, "Access Rules for C++," by Phil Brown.





---

# 1 Evolution of C++

---

<b>The Evolution of C++: 1985 to 1989</b>	1-1
Abstract	1-1
Introduction	1-1
Overview	1-2
Access Control	1-3
■ protected Members	1-3
■ Access Control Syntax	1-5
■ Adjusting Access	1-6
■ Details	1-7
Overloading Resolution	1-8
Type-Safe Linkage	1-11
Multiple Inheritance	1-14
Base and Member Initialization	1-18
Abstract Classes	1-21
Static Member Functions	1-22
const Member Functions	1-23
Initialization of static Members	1-24
Pointers to Members	1-25
User-Defined Free Store Management	1-28
■ Assignment to <code>this</code>	1-28
■ Class-Specific Free Store Management	1-29
■ Inheritance of <code>operator new()</code>	1-30
■ Overloading <code>operator new()</code>	1-31
■ Controlling Deallocation	1-32
■ Placement of Objects	1-34
■ Memory Exhaustion	1-35
■ Explicit Calls of Destructors	1-35
■ Size Argument to <code>operator delete()</code>	1-35
Assignment and Initialization	1-36
Operator <code>&gt;</code>	1-39
Operator <code>,</code>	1-40
Initialization of static Objects	1-41
Resolutions	1-41
■ Function Argument Syntax	1-41
■ Declaration and Expression Syntax	1-42
■ Enumerators	1-43
■ The <code>const</code> Specifier	1-44
■ Function Types	1-45
■ Lvalues	1-45
■ Multiple Name Spaces	1-46
■ Function Declaration Syntax	1-47
Conclusions	1-48

---

## Footnotes

1-49



---

# The Evolution of C++: 1985 to 1989

**NOTE**

This chapter is taken directly from a paper by Bjarne Stroustrup.

## Abstract

*The C++ Programming Language* describes C++ as defined and implemented in August 1985. This paper describes the growth of the language since then and clarifies a few points in the definition. It is emphasized that these language modifications are extensions; C++ has been and will remain a stable language suitable for long term software development. The main new features of C++ are: multiple inheritance, type-safe linkage, better resolution of overloaded functions, recursive definition of assignment and initialization, better facilities for user-defined memory management, abstract classes, static member functions, const member functions, protected members, overloading of operator `->`, and pointers to members. These features are provided in the 2.0 release of C++.

## Introduction

As promised in *The C++ Programming Language*, C++ has been evolving to meet the needs of its users. This evolution has been guided by the experience of users of widely varying backgrounds working in a great range of application areas. The primary aim of the extensions has been to enhance C++ as a language for data abstraction and object-oriented programming in general and to enhance it as a tool for writing high-quality libraries of user-defined types in particular. By a high-quality library I mean a library that provides a concept to a user in the form of one or more classes that are convenient, safe, and efficient to use. In this context, *safe* means that a class provides a specific type-secure interface between the users of the library and its providers; *efficient* means that use of the class does not impose large overhead in run-time or space on the user compared with hand written C code.

Portability of at least some C++ implementations is a key design goal. Consequently, extensions that would add significantly to the porting time or to the demands on resources for a C++ compiler have been avoided. This ideal of language evolution can be contrasted with plausible alternative directions such as making programming convenient

- at the expense of efficiency or structure;
- for novices at the expense of generality;
- in a specific application area by adding special purpose features to the language;
- by adding language features to increase integration into a specific C++ environment

For some ideas of where these ideas of language evolution might lead C++ see Chapter 4.

A programming language is only one part of a programmer's world. Naturally, work is being done in many other fields (such as tools, environments, libraries, education and design methods) to make C++ programming more pleasant and effective. This paper, however, deals strictly with language and language implementation issues.

## Overview

This paper is a brief overview of new language features; it is not a manual or a tutorial. The reader is assumed to be familiar with the language as described in *The C++ Programming Language* and to have sufficient experience with C++ to recognize many of the problems that the features described here are designed to solve or alleviate. Most of the extensions take the form of removing restrictions on what can be expressed in C++.

### ■ Access Control

First some extensions to C++'s mechanisms for controlling access to class members are presented. Like all extensions described here, they reflect experience with the mechanisms they extend and the increased demands posed by the use of C++ in relatively large and complicated projects.

### ■ Overloading Resolution

### ■ Type-Safe Linkage

C++ software is increasingly constructed by combining semi-independent components (modules, classes, libraries, etc.) and much of the effort involved in writing C++ goes into the design and implementation of such components. To help these activities, the rules for overloading function names and the rules for linking separately compiled code have been refined.

### ■ Multiple Inheritance

### ■ Base and Member Initialization

### ■ Abstract Classes

Classes are designed to represent general or application specific concepts. Originally, C++ provided only single inheritance, that is, a class could have at most one direct base class, so that the directly representable relations between classes had to be a tree structure. This is sufficient in a large majority of cases. However, there are important concepts for which relations cannot be naturally expressed as a tree, but where a directed acyclic graph is suitable. As a consequence, C++ has been extended to support multiple inheritance, that is, a class can have several immediate base classes, directly. The rules for ambiguity resolution and for initialization of base classes and members have been refined to cope with this extension.

### ■ static Member Functions

### ■ const Member Functions

### ■ Initialization of static Members

### ■ Pointers to Members

The concept of a class member has been generalized. Most important, the introduction of `const` member functions allows the rules for `const` class objects to be enforced.

### ■ User-Defined Free Store Management

The mechanisms for user-defined memory management have been refined and extended to the point where the old and inelegant "assignment to this" mechanism has become redundant.

### ■ Assignment and Initialization

The rules for assignment and initialization of class objects have been made more general and uniform to require less work from the programmer.

- Operator ->
- Operator ,
- Initialization of static objects
- Some minor extensions are presented.
- Resolutions

The last section does not describe language extensions but presents the resolution of some details of the C++ language definition.

- In addition to the extensions mentioned here, many details of the definition of C++ have been modified for greater compatibility with the proposed ANSI C standard.

## Access Control

The rules and syntax for controlling access to class members have been made more flexible.

### protected Members

The simple private/public model of data hiding served C++ well where C++ was used essentially as a data abstraction language and for a large class of problems where inheritance was used for object-oriented programming. However, when derived classes are used there are two kinds of users of a class: derived classes and "the general public." The members and friends that implement the operations on the class operate on the class objects on behalf of these users. The private/public mechanism allows the programmer to distinguish clearly between the implementors and the general public, but does not provide a way of catering specifically to derived classes. This often caused the data hiding mechanisms to be ignored:

```
class X {
    // ...
public:
    int a;      // "a" should have been private
               // don't use it unless you are
               // a member of a derived class
    // ...
};
```

Another symptom of this problem was overuse of friend declarations:

```

class X {
    friend class D1;
    friend class D2;
    // ...
    friend class Dn;
    // ...
    int a;
public:
    // ...
};
// Another bad way:
// make derived classes friends
// to give access to private member "a"

```

The solution adopted was **protected members**. A **protected member** is accessible to members and friends of a derived class as if it were **public**, but inaccessible to "the general public" just like **private** members. For example:

```

class X {
// private by default:
    int priv;
protected:
    int prot;
public:
    int publ;
};

class Y : public X {
    void mf();
};

Y::mf()
{
    priv = 1;           // error: priv is private
    prot = 2;          // OK: prot is protected and mf2() is a member of Y
    publ = 3;          // OK: publ is public
}

void f(Y* p)
{
    p->priv = 1;        // error: priv is private
    p->prot = 2;        // error: prot is protected and f() is not a friend
                       // or a member of X or Y
    p->publ = 3;        // OK: publ is public
}

```

A more realistic example of the use of **protected** can be found in this chapter under "Multiple Inheritance."

A friend function has the same access to protected members as a member function.

A subtle point is that accessibility of protected members depends on the static type of the pointer used in the access. A member or a friend of a derived class has access only to protected members of objects that are known to be of its derived type. For example:

```
class Z : public Y {
    // ...
};

void Y::mf()
{
    prot = 2;    // OK: prot is protected and mf() is a member function

    X a;
    a.prot = 3; // error: prot is protected and a is not a Y

    X* p = this;
    p->prot = 3; // error: prot is protected
                //          and p is not a pointer to Y

    Z b;
    b.prot = 4; // OK: prot is protected
                //          and mf() is a member and a Z is a Y
}
```

A protected member of a class base is a protected member of a class derived from base if the derivation is public and private otherwise.

### Access Control Syntax

The following example confuses most beginners and even experts get bitten sometimes:

```
class X {
    // ...
public:
    int f();
};

class Y : X { /* ... */ };

int g(Y* p)
{
    // ...
    return p->f(); // error!
};
```

Here X is by default declared to be a private base class of Y. This means that X is not a subtype of Y so the call `p->f()` is illegal because Y does not have a public function `f()`. Private base classes are quite an important concept, but to avoid confusion it is recommended that they be declared **private**

explicitly:

```
class Y : private X { /* ... */ };
```

Several public, private, and protected sections are allowed in a class declaration:

```
class X {
public:
    int i1;
private:
    int i2;
public:
    int i3;
};
```

These sections can appear in any order. This implies that the public interface of a class may appear textually before the private "implementation details":

```
class S {
public:
    f();
    int i1;
    // ...
private:
    g();
    int i2;
    // ...
};
```

### Adjusting Access

When a class `base` is used as a private base class all of its members are considered private members of the derived class. The syntax `base-class-name :: member-name` can be used to restore access of a member to what it was in the base:

```
class base {
public:
    int publ;
protected:
    int prot;
private:
    int priv;
};
```



```

class derived : private base {
protected:
    base::prot;           // protected in derived
public:
    base::publ;          // public in derived
};

```

This mechanism cannot be used to grant access that was not already granted by the base class:

```

class derived2 : public base {
public:
    base::priv;          // error: base::priv is private
};

```

This mechanism can be used only to restore access to what it was in the base class:

```

class derived3: private base {
protected:
    base::publ;          // error: base::publ was public
};

```

This mechanism cannot be used to remove access already granted:

```

class derived4: public base {
private:
    base::publ;          // error: base::publ is public
};

```

We considered allowing the last two forms and experimented with them, but found that they caused total confusion among users about the access control rules and the rules for private and public derivation. Similar considerations led to the decision not to introduce the (otherwise perfectly reasonable) concept of protected base classes.

## Details

A friend function has the same access to base class members as a member function. For example:

```

class base {
protected:
    int prot;
public:
    int publ;
};

class derived : private base {
public:
    friend int fr(derived *p) { return p->prot; }
    int mem() { return prot; }
};

```

In particular, a friend function can perform the conversion of a pointer to a derived class to its private base class:

```
class derived2 : private base {
public:
    friend base* fr(derived *p) { return p; }
    base* mem() { return this; }
};

base* f(derived* p)
{
    return p;                // error: cannot convert;
                             // base is a private base class of derived
}
```

However, friendship is *not* transitive. For example:

```
class X {
friend class Y;
private:
    int a;
};

class Y {
    friend int fr(Y *p)
        { return p->a; } // error: fr() is not a friend of X
    int mem(Y* p)
        { return p->a; } // OK: mem() is a friend of X
};
```

## Overloading Resolution

The C++ overloading mechanism was revised to allow resolution of types that used to be “too similar” and to gain independence of declaration order. The resulting scheme is more expressive and catches more ambiguity errors. Consider:

```
double abs(double);
float abs(float);
```

To cope with single precision floating point arithmetic it must be possible to declare both of these functions; now it is. The effect of any call of `abs()` given the declarations above is the same if the order of declarations was reversed:

```
float abs(float);
double abs(double);
```

Here is a slightly simplified explanation of the new rules. Note that with the exception of a few cases where the the older rules allowed order dependence the new rules are compatible and old programs produce identical results under the new rules. For the last two years or so C++ implementations have issued warnings for the now “outlawed” order dependent resolutions.

C++ distinguishes five kinds of "matches":

- Match using no or only unavoidable conversions (for example, array name to pointer, function name to pointer to function, and T to const T).
- Match using integral promotions (as defined in the proposed ANSI C standard; that is, char to int, short to int and their unsigned counterparts) and float to double.
- Match using standard conversions (for example, int to double, derived\* to base\*, unsigned int to int).
- Match using user defined conversions (both constructors and conversion operators).
- Match using the ellipsis ... in a function declaration.

Consider first functions of a single argument. The idea is always to choose the "best" match, that is the one highest on the list above. If there are two best matches the call is ambiguous and thus a compile time error. For example,

```
float abs(float);
double abs(double);
int abs(int);
unsigned abs(unsigned);
char abs(char);

abs(1);           // abs(int);
abs(1U);         // abs(unsigned);
abs(1.0);        // abs(double);
abs(1.0F);       // abs(float);
abs('a');       // abs(char);
abs(1L);         // error: ambiguous, abs(int) or abs(double)
```

Here, the calls take advantage of the ANSI C notation for unsigned and float literals and of the C++ rule that a character constant is of type char<sup>1</sup>. The call with the long argument 1L is ambiguous since abs(int) and abs(double) would be equally good matches (match with standard conversion).

Hierarchies established by public class derivations are taken into account in function matching and where a standard conversion is needed the conversion to the "most derived" class is chosen. A void\* argument is chosen only if no other pointer argument matches. For example:

```
class B { /* ... */ };
class BB : public B { /* ... */ };
class BBB : public BB { /* ... */ };

f(B*);
f(BB*);
f(void*);

void g(BBB* pbbb, int* pi)
{
    f(pbbb);           // f(BB*);
    f(pi);             // f(void*);
}
```

This ambiguity resolution rule matches the rule for virtual function calls where the member from the most derived class is chosen.

If two otherwise equally good matches differ in terms of `const`, the `const` specifier is taken into account in function matching for pointer and reference arguments. For example:

```
char* strtok(char*, const char*);
const char* strtok(const char*, const char*);

void g(char* vc, const char* vcc)
{
    char* p1 = strtok(vc, "a"); // strtok(char*, char*);
    const char* p2 = strtok(vcc, "a"); // strtok(const char*, char*);
    char* p3 = strtok(vcc, "a"); // error
}
```

In the third case, `strtok(const char*, const char*)` is chosen because `vcc` is a `const char*`. This leads to an attempt to initialize the `char*` `p3` with the `const char*` result.

For calls involving more than one argument a function is chosen provided it has a better match than every other function for at least one argument and at least as good a match as every other function for every argument. For example:

```

class complex { ... complex(double); };

f(int,double);
f(double,int);
f(complex,int);
f(int ...);
f(complex ...);

complex z = 1;

f(1, 2.0);          // f(int,double);
f(1.0, 2);          // f(double,int);
f(z, 1.2);          // f(complex,int);
f(z, 1, 3);         // f(complex ...);
f(2.0, z);          // f(int ...);
f(1, 1);            // error: ambiguous, f(int,double) and f(double,int)

```

The unfortunate narrowing from `double` to `int` in the third and the second to last cases causes warnings. Such narrowings are allowed to preserve compatibility with C. In this particular case the narrowing is harmless, but in many cases `double` to `int` conversions are value destroying and they should never be used thoughtlessly.

As ever, at most one user-defined and one built-in conversion may be applied to a single argument.

## Type-Safe Linkage

Originally, C++ allowed a name to be used for more than one name ("to be overloaded") only after an explicit overload declaration. For example:

```

overload max;                // 'overload' now obsolete
int max(int,int);
double max(double,double);

```

It used to be considered too dangerous simply to use a name for two functions without previous declaration of intent. For example:

```

int abs(int);
double abs(double);          // used to be an error

```

This fear of overloading had two sources:

- concern that undetected ambiguities could occur
- concern that a program could not be properly linked unless the programmer explicitly declared where overloading was to take place.

The former fear proved largely groundless and the few problems found in actual use have been taken care of by the new order-independent overloading resolution rules. The latter fear proved to have a basis in a general problem with C separate compilation rules that had nothing to do with overloading.

On the other hand, the redundant **overload** declarations themselves became an increasingly serious problem. Since they had to precede (or be part of) the declarations they were to enable, it was not possible to merge pieces of software using the same function name for different functions unless both pieces had declared the function overloaded. This is not usually the case. In particular, the name one wants to overload is often the name of a C standard library function declared in a C header. For example, one might have standard headers like this:

```
/* Header for C standard math library, math.h: */
double sqrt(double);
/* ... */

// header for C++ standard complex arithmetic library, complex.h:
overload sqrt;
complex sqrt(complex);
// ...
```

and try to use them like this:

```
#include <math.h>
#include <complex.h>
```

This causes a compile time error when the **overload** for `sqrt()` is seen after the first declaration of `sqrt()`. Rearranging declarations, putting constraints on the use of header files, and sprinkling **overload** declarations everywhere "just in case" can alleviate this kind of problem, but we found the use of such tricks unmanageable in all but the simplest cases. Abolishing **overload** declarations (and getting rid of the **overload** keyword in the process) is a much better idea.

Doing things this way does pose an implementation problem, though. When a single name is used for several functions, one must be able to tell the linker which calls are to be linked to which function definitions. Ordinary linkers are not equipped to handle several functions with the same name. However, they can be tricked into handling overloaded names by encoding type information into the names seen by the linker. For example, the names for these two functions:

```
double sqrt(double);
complex sqrt(complex);
```

become:

```
sqrt__Fd
sqrt__F7complex
```

in the compiler output to the linker. The user and the compiler see the C++ source text where the type information serves to disambiguate and the linker sees the names that have been disambiguated by adding a textual representation of the type information. Naturally, one might have a linker that understood about type information, but it is not necessary and such linkers are certainly not common.

Using this encoding or any equivalent scheme solves a long standing problem with C linkage. Inconsistent function declarations in separately compiled code fragments are now caught. For example:

```

// file1.c:

extern name* lookup(table* tbl, const char* name);

// ...

void some_fct(char* s)
{
    name* n = lookup(tbl, s);
}

```

looks plausible and the compiler can find no fault with it. However, if the definition of `lookup()` turns out to be:

```

// file2.c:

int lookup(table* tbl, const char* name, int index)
{
    // ...
}

```

the linker now has enough information to catch the error.

Finally, we have to face the problem of linking to code fragments written in other languages that do not know the C++ type system or use the C++ type encoding scheme. One could imagine all compilers for all languages on a system agreeing on a type system and a linkage scheme such that linkage of code fragments written in different languages would be safe. However, since this will not typically be the case we need a way of calling functions written in a language that does not use a type-safe linkage scheme and a way to write C++ functions that obey the different (and typically unsafe) linkage rules for other languages. This is done by explicitly specifying the name of the desired linkage convention in a declaration:

```
extern "C" double sqrt(double);
```

or by enclosing whole groups of declarations in a linkage directive:

```
extern "C" {
#include <math.h>
}

```

By applying the second form of linkage directive to standard header files one can avoid littering the user code with linkage directives. This type-safe linkage mechanism is discussed in detail in Chapter 6.

## Multiple Inheritance

Consider writing a simulation of a network of computers. Each node in the network is represented by an object of class `Switch`, each user or computer by an object of class `Terminal`, and each communication line by an object of class `Line`. One way to monitor the simulation (or a real network of the same structure) would be to display the state of objects of various classes on a screen. Each object to be displayed is represented as an object of class `Displayed`. Objects of class `Displayed` are under control of a display manager that ensures regular update of a screen and/or data base. The classes `Terminal` and `Switch` are derived from a class `Task` that provides the basic facilities for co-routine style behavior. Objects of class `Task` are under control of a task manager (scheduler) that manages the real processor(s).

Ideally `Task` and `Displayed` are classes from a standard library. If you want to display a terminal, class `Terminal` must be derived from class `Displayed`. Class `Terminal`, however, is already derived from class `Task`. In a single inheritance language, such as `Simula67`, we have only two ways of solving this problem: deriving `Task` from `Displayed` or deriving `Displayed` from `Task`. Neither is ideal since they both create a dependency between the library versions of two fundamental and independent concepts. Ideally, one would want to be able to say that a `Terminal` is a `Task` *and* a `Displayed`; that a `Line` is a `Displayed` *but not* a `Task`; and that a `Switch` is a `Task` *but not* a `Displayed`.

The ability to express this class hierarchy, that is, to derive a class from more than one base class, is usually referred to as *multiple inheritance*. Other examples involve the representation of various kinds of windows in a window system and the representation of various kinds of processors and compilers for a multi-machine, multi-environment debugger.

In general, multiple inheritance allows a user to combine concepts represented as classes into a composite concept represented as a derived class. C++ allows this to be done in a general, type-safe, compact, and efficient manner. The basic scheme allows independent concepts to be combined and ambiguities to be detected at compile time. An extension of the base class concept, called *virtual base classes*, allows dependencies between classes in an inheritance DAG (Directed Acyclic Graph) to be expressed.

Ambiguous uses are detected at compile time:

```
class A { f(); /* ... */ };
class B { f(); /* ... */ };
class C : public A, public B { };

void g() {
    C* p;
    p->f();           // error: ambiguous
}
```

Note that it is not an error to combine classes containing the same member names in an inheritance DAG. The error occurs only when a name is used in an ambiguous way — and only then does the compiler have to reject the program. This is important since most potential ambiguities in a program never appear as actual ambiguities. Considering a potential ambiguity an error would be far too restrictive<sup>2</sup>.



Typically one would resolve the ambiguity by adding a function:

```
class C : public A, public B {
public:
    f()
    {
        // C's own stuff
        A::f();
        B::f();
    }
    // ...
};
```

This example shows the usefulness of naming members of a base class explicitly with the name of the base class. In the restricted case of single inheritance, this way is marginally less elegant than the approach taken by Smalltalk and other languages (simply referring to "my super class" instead of using an explicit name). However, the C++ approach extends cleanly to multiple inheritance.

A class can appear more than once in an inheritance DAG:

```
class A : public L { /* ... */ };
class B : public L { /* ... */ };
class C : public A, public B { /* ... */ };
```

In this case, an object of class C has two sub-objects of class L, namely A::L and B::L. This is often useful, as in the case of an implementation of lists requiring each element on a list to contain a link element. If in the example above L is a link class then a C can be on both the list of As and the list of Bs at the same time.

Virtual functions work as expected; that is the version from the most derived class is used:

```
class A { public: virtual f(); /* ... */ };
class B { public: virtual g(); /* ... */ };
class C : public A, public B { public: f(); g(); /* ... */ };

void ff()
{
    C obj;
    A* pa = &obj;
    B* pb = &obj;

    pa->f();           // calls C::f
    pb->g();           // calls C::g
}
```

This way of combining classes is ideal for representing the union of independent or nearly independent concepts. However, in some interesting cases, such as the window example, a more explicit way of expressing sharing and dependency is needed.

Virtual base classes provide a mechanism for sharing between sub-objects in an inheritance DAG and for expressing dependencies among such sub-objects:

```
class A : public virtual W { /* ... */ };
class B : public virtual W { /* ... */ };
class C : public A, public B, public virtual W { /* ... */ };
```

In this case there is only one object of class W in class C.

Constructing the tables for virtual function calls can get quite complicated when virtual base classes are used. However, virtual functions work as usual by choosing the version from the most derived class in a call:

```
class W {
    // ...
public:
    virtual void f();
    virtual void g();
    virtual void h();
    virtual void k();
    // ...
};

class AW : public virtual W { /* ... */ public: void g(); /* ... */ };
class BW : public virtual W { /* ... */ public: void f(); /* ... */ };
class CW : public AW, public BW, public virtual W {
    // ...
public:
    void h();
    // ...
};

CW* pcw = new CW;

pcw->f();           // invokes BW::f()
pcw->g();           // invokes AW::g()
pcw->h();           // invokes CW::h()
((AW*)pcw)->f();  // invokes BW::f() !!!
```

The reason that `BW::f()` is invoked in the last example is that the only `f()` in an object of class `CW` is the one found in the (shared) sub-object `W`, and that one has been overridden by `B::f()`.

Ambiguities are easily detected at the point where `CW`'s table of virtual functions is constructed. The rule for detecting ambiguities in a class DAG is that all re-definitions of a virtual function from a virtual base class must occur on a single path through the DAG. The example above can be drawn like

this:

Figure 1-1: A Directed Acyclic Graph

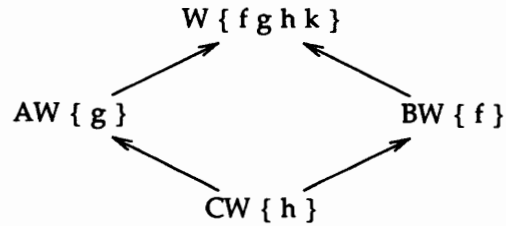

Note that a call "up" through one path of the DAG to a virtual function may result in the call of a function (re-defined) in another path (as happened in the call `((AW*)pcw)->f()` in the example above). In this example, an ambiguity would occur if a function `f()` was added to `AW`. This ambiguity might be resolved by adding a function `f()` to `CW`.

Programming with virtual bases is trickier than programming with non-virtual bases. The problem is to avoid multiple calls of a function in a virtual class when that is not desired. Here is a possible style:

```

class W {
    // ...
protected:
    _f() { my stuff }
    // ...
public:
    f() { _f(); }
    // ...
};
  
```

Each class provides a protected function doing "its own stuff," `_f()`, for use by derived classes and a public function `f()` as the interface for use by the "general public."

```

class A : public virtual W {
    // ...
protected:
    _f() { my stuff }
    // ...
public:
    f() { _f(); W::_f(); }
    // ...
};
  
```

A derived class `f()` does its "own stuff" by calling `_f()` and its base classes' "own stuff" by calling their `_f()`s.

```
class B : public virtual W {
    // ...
protected:
    _f() { my stuff }
    // ...
public:
    f() { _f(); W::_f(); }
    // ...
};
```

In particular, this style enables a class that is (indirectly) derived twice from a class `W` to call `W::f()` once only:

```
class C : public A, public B, public virtual W {
    // ...
protected:
    _f() { my stuff }
    // ...
public:
    f() { _f(); A::_f(); B::_f(); W::_f(); }
    // ...
};
```

Method combination schemes, such as the ones found in Lisp systems with multiple inheritance, were considered as a way of reducing the amount of code a programmer needed to write in cases like the one above. However, none of these schemes appeared to be sufficiently simple, general, and efficient enough to warrant the complexity it would add to C++.

As described in Chapter 5 a virtual function call is about as efficient as a normal function call — even in the case of multiple inheritance. The added cost is 5 to 6 memory references per call. This compares with the 3 to 4 extra memory references incurred by a virtual function call in a C++ compiler providing only single inheritance. The multiple inheritance scheme currently used causes an increase of about 50% in the size of the tables used to implement the virtual functions compared with the older single inheritance implementation. To offset that, the multiple inheritance implementation optimizes away quite a few spurious tables generated by the older single-inheritance implementations so that the memory requirement of a program using virtual functions actually decreases in most cases.

It would have been nice if there had been absolutely no added cost for the multiple inheritance scheme when only single inheritance is used. Such schemes exist, but involve the use of tricks that cannot be done by a C++ compiler generating C.

## Base and Member Initialization

The syntax for initializing base classes and members has been extended to cope with multiple inheritance and the order of initialization has been more precisely defined. Leaving the initialization order unspecified in the original definition of C++ gave an unnecessary degree of freedom to language implementors at the expense of the users. In most cases, the order of initialization of members doesn't matter and in most cases where it does matter, the order dependency is an indication of bad design. In a few cases, however, the programmer absolutely needs control of the order of initialization. For example, consider transmitting objects between machines. An object must be re-constructed by a

receiver in exactly the reverse order in which it was decomposed for transmission by a sender. This cannot be guaranteed for objects communicated between programs compiled by compilers from different suppliers unless the language specifies the order of construction.

Consider:

```
class A { public: A(int); A(); /* ... */ };
class B { public: B(int); B(); /* ... */ };

class C : public A, public B {
    const a;
    int& b;
public:
    C(int&);
};
```

In a constructor the sub-objects representing base classes can be referred to by their class names:

```
C::C(int& rr) : A(1), B(2), a(3), b(rr) { /* ... */ }
```

The initialization takes place in the order of declaration in the class with base classes initialized before members<sup>3</sup>, so the initialization order for class C is A, B, a, b. This order is independent of the order of explicit initializers so

```
C::C(int& rr) : b(rr), B(2), a(3), A(1) { /* ... */ }
```

also initializes in the declaration order A, B, a, b.

The reason for ignoring the order of initializers is to preserve the usual FIFO ordering of constructor and destructor calls. Allowing two constructors to use different orders of initialization of bases and members would constrain implementations to use more dynamic and more expensive strategies.

Using the base class name explicitly clarifies even the case of single inheritance without member initialization:

```
class vector {
    // ...
public:
    vector(int);
    // ...
};

class vec : public vector {
    // ...
public:
    vec(int, int);
    // ...
};
```

It is reasonably clear even to novices what is going on here:

```
vec::vec(int low, int high) : vector(high-low-1) { /* ... */ }
```

On the other hand, this version:

```
vec::vec(int low, int high) : (high-low-1) { /* ... */ }
```

has caused much confusion over the years. The old-style base class initializer is of course still accepted. It can be used only in the single inheritance case since it is ambiguous otherwise.

A virtual base is constructed before any of its derived classes. Virtual bases are constructed before any non-virtual bases and in the order they appear on a depth-first left-to-right traversal of the inheritance DAG. This rule applies recursively for virtual bases of virtual bases.

A virtual base is initialized by the "most derived" class of which it is a base. For example:

```
class V { public: V(); V(int); /* ... */ };
class A : public virtual V { public: A(); A(int); /* ... */ };
class B : public virtual V { public: B(); B(int); /* ... */ };
class C : public A, public B { public: C(); C(int); /* ... */ };
```

```
A::A(int i) : V(i) { /* ... */ }
B::B(int i) { /* ... */ }
C::C(int i) { /* ... */ }
```

```
V v(1); // use V(int)
A a(2); // use V(int)
B b(3); // use V()
C c(4); // use V()
```

The order of destructor calls is defined to be the reverse order of appearance in the class declaration (members before bases). There is no way for the programmer to control this order – except by the declaration order. A virtual base is destroyed after all of its derived classes.

It might be worth mentioning that virtual destructors are (and always have been) allowed:

```
struct B { /* ... */ virtual ~B(); };

struct D : B { ~D(); };

void g() {
    B* p = new D;
    delete p; // D::~~D() is called
}
```

The word **virtual** was chosen for virtual base classes because of some rather vague conceptual similarities to virtual functions and to avoid introducing yet another keyword.

## Abstract Classes

One of the purposes of static type checking is to detect mistakes and inconsistencies before a program is run. It was noted that a significant class of detectable errors was escaping C++'s checking. To add insult to injury, the language actually forced programmers to write extra code and generate larger programs to make this happen.

Consider the classic "shape" example. Here, we must first declare a class `shape` to represent the general concept of a shape. This class needs two virtual functions `rotate()` and `draw()`. Naturally, there can be no objects of class `shape`, only objects of specific shapes. Unfortunately C++ did not provide a way of expressing this simple notion.

The C++ rules specify that virtual functions, such as `rotate()` and `draw()`, must be defined in the class in which they are first declared. The reason for this requirement is to ensure that traditional linkers can be used to link C++ programs and to ensure that it is not possible to call a virtual function that has not been defined. So the programmer writes something like this:

```
class shape {
    point center;
    color col;
    // ...
public:
    where() { return center; }
    move(point p) { center=p; draw(); }
    virtual void rotate(int) { error("cannot rotate"); abort(); }
    virtual void draw() { error("cannot draw"); abort(); }
    // ...
};
```

This ensures that innocent errors such as forgetting to define a `draw()` function for a class derived from `shape` and silly errors such as creating a "plain" shape and attempting to use it cause run time errors. Even when such errors are not made, memory can easily get cluttered with unnecessary virtual tables for classes such as `shape` and with functions that are never called, such as `draw()` and `rotate()`. The overhead for this can be noticeable.

The solution is simply to allow the user to say that a virtual function does not have a definition; that is, that it is a "pure virtual function." This is done by an initializer `=0`:

```
class shape {
    point center;
    color col;
    // ...
public:
    where() { return center; }
    move(point p) { center=point; draw(); }
    virtual void rotate(int) = 0; // pure virtual function
    virtual void draw() = 0; // pure virtual function
    // ...
};
```

A class with one or more pure virtual functions is an abstract class. An abstract class can only be used as a base for another class. In particular, it is not possible to create objects of an abstract class. A class

derived from an abstract class must either define the pure virtual functions from its base or again declare them to be pure virtual functions.

The notion of pure virtual functions was chosen over the idea of explicitly declaring a class to be abstract because the selective definition of functions is much more flexible.

## Static Member Functions

A static data member of a class is a member for which there is only one copy rather than one per object and which can be accessed without referring to any particular object of the class it is a member of. The reason for using static members is to reduce the number of global names, to make obvious which static objects logically belong to which class, and to be able to apply access control to their names. This is a boon for library providers since it avoids polluting the global name space and thereby allows easier writing of library code and safer use of multiple libraries. These reasons apply for functions as well as for objects. In fact, *most* of the names a library provider wants local are function names. It was also observed that nonportable code, such as

```
((X*)0)->f();
```

was used to simulate static member functions. This trick is a time bomb because sooner or later someone will make an `f()` that is used this way `virtual` and the call will fail horribly because there is no `X` object at address zero. Even where `f()` is not `virtual` such calls will fail under some implementations of dynamic linking.

A static member function is a member so that its name is in the class scope and the usual access control rules apply. A static member function is not associated with any particular object and need not be called using the special member function syntax. For example:

```
class X {
    int mem;
public:
    static void f(int,X*);
};

void g()
{
    X obj;
    f(1,&obj);           // error (unless there really is
                        // a global function f())
    X::f(1,&obj);       // fine
    obj.f(1,&obj);      // also fine
}
```

Since a static member function isn't called for a particular object it has no `this` pointer and cannot access members without explicitly specifying an object. For example:



```

void X::f(int i, X* p)
{
    mem = i;           // error: which mem?
    p->mem = i;        // fine
}

```

## const Member Functions

Consider this example:

```

class s {
    int aa;
public:
    void mutate() { aa++; }
    int value() { return aa; }
};

void g()
{
    s o1;
    const s o2;
    o1.mutate();
    o2.mutate();
    int i = o1.value() + o2.value();
}

```

It seems clear that the call `o2.mutate()` ought to fail since `o2` is a `const`.

The reason this rule until now has not been enforced is simply that there was no way of distinguishing a member function that may be invoked on a `const` object from one that may not. In general, the compiler cannot deduce which functions will change the value of an object. For example, had `mutate()` been defined in a separately compiled source file the compiler would not have been able to detect the problem at compile time.

The solution to this has two parts. First `const` is enforced so that "ordinary" member functions cannot be called for a `const` object. Then we introduce the notion of a `const` member function, that is, a member function that may be called for all objects including `const` objects. For example:

```

class X {
    int aa;
public:
    void mutate() { aa++; }
    int value() const { return aa; }
};

```

Now `X::value()` is guaranteed not to change the value of an object and can be used on a `const` object whereas `X::mutate()` can only be called for non-`c` `const` objects:

```
int g()
{
    X o1;
    const X o2;
    o1.mutate();    // fine
    o2.mutate();    // error
    return o1.value() + o2.value(); // fine
}
```

In a `const` member function of `X` the `this` pointer points to a `const X`. This ensures that non-devious attempts to modify the value of an object through a `const` member will be caught:

```
class X {
    int a;
    void cheat() const { a++; }    // error
};
```

Note that the use of `const` as a suffix to `()` is consistent with the use of `const` as a suffix to `*`.

## Initialization of static Members

A `static` data member of a class must be defined somewhere. The `static` declaration in the class declaration is only a declaration and does not set aside storage or provide an initializer.

This is a change from the original C++ definition of `static` members, which relied on implicit definition of `static` members and on implicit initialization of such members to 0. Unfortunately, this style of initialization cannot be used for objects of all types. In particular, objects of classes with constructors cannot be initialized this way. Furthermore, this style of initialization relied on linker features that are not universally available. Fortunately, in the implementations where this used to work it will continue to work for some time, but conversion to the stricter style described here is strongly recommended.

Here is an example:

```
class X {
    static int i;
    int j;
    X(int);
    int read();
};

class Y {
    static X a;
    int b;
    Y(int);
    int read();
};
```

Now `X::i` and `Y::a` have been declared and can be referred to, but somewhere definitions must be

provided. The natural place for such definitions is with the definitions of the class member functions. For example:

```
// file X.c:
X::X(int jj) { j = jj; }
int X::read() { return j; }
int X::i = 3;

// file Y.c:
Y::Y(int bb) { b = bb; }
int Y::read() { return b; }
X Y::a = 7;
```

## Pointers to Members

As mentioned in *The C++ Programming Language*, it was an obvious deficiency that there was no way of expressing the concept of a pointer to a member of a class in C++. This led to the need to "cheat" the type system in cases, such as error handling, where pointers to functions are traditionally used. Consider this example:

```
struct S {
    int mf(char*);
};
```

The structure `S` is declared to be a (trivial) type for which the member function `mf()` is declared. Given a variable of type `S` the function `mf()` can be called:

```
S a;
int i = a.mf("hello");
```

The question is "*What is the type of `mf()`?*"

The equivalent type of a non-member function

```
int f(char*);
```

is

```
int (char*)
```

and a pointer to such a function is of type

```
int (*)(char*)
```

Such pointers to "normal" functions are declared and used like this:

```
int f(char*);           // declare function
int (*pf)(char*) = &f; // declare and initialize pointer to function
int i = (*pf)("hello"); // call function through pointer
```

A similar syntax is introduced for pointers to members of a specific class. In a definition `mf()` appears as:

```
int S::mf(char*)
```

The type of `S::mf` is:

```
int S:: (char*)
```

that is, "member of `S` that is a function taking a `char*` argument and returning an `int`." A pointer to such a function is of type:

```
int (S::*)(char*)
```

That is, the notation for pointer to member of class `S` is `S::*`. We can now write:

```
        // declare and initialize pointer to member function
int (S::*pmf)(char*) = &S::mf;

S a;
        // call function through pointer for the object ``a``
int i = (a.*pmf)("hello");
```

The syntax isn't exactly pretty, but neither is the C syntax it is modeled on.

A pointer to member function can also be called given a pointer to an object:

```
S* p;
        // call function through pointer for the object ``*p``:
int i = (p->*pmf)("hello");
```

In this case, we might have to handle virtual functions:

```

struct B {
    virtual f();
};

struct D : B {
    f();
};

int ff(B* pb, int (B::*pbf)())
{
    return (pb->*pbf)();
};

void gg()
{
    D dd;
    int i = ff(&dd, &B::f);
}

```

This causes a call of `D::f()`. Naturally, the implementation involves a lookup in `dd`'s table of virtual functions exactly as a call to a virtual function that is identified by name rather than by a pointer. The overhead compared to a "normal function call" is the usual about five memory references (dependent on the machine architecture).

It is also possible to declare and use pointers to members that are not functions:

```

struct S {
    int mem;
};

int S::* psm = &S::mem;

void f(S* ps)
{
    ps->*psm = 2;
}

void g()
{
    S a;
    f(&a);
}

```

This is a complicated way of assigning 2 to `a.mem`.

## User-Defined Free Store Management

C++ provides the operators `new` and `delete` to allocate memory on the free store and to release store allocated this way for reuse. Occasionally a user needs a finer-grained control of allocation and deallocation. The first section below shows “the bad old way” of doing this and the following sections shows how the usual scope and overloaded function resolution mechanisms can be exploited to achieve similar effects more elegantly. This means that assignment to `this` is an anachronism and will be removed from the implementations of C++ after a decent interval. This will allow the type of `this` in a member function of class `X` to be changed to `X *const`.

### Assignment to `this`

If a user wanted to take over allocation of objects of a class `X` the only way used to be to assign to `this` on each path through every constructor for `X`. Similarly, the user could take control of deallocation by assigning to `this` in a destructor. This is a very powerful and general mechanism. It is also non-obvious, error prone, repetitive, too subtle when derived classes are used, and essentially unmanageable when multiple inheritance is used. For example:

```
class X {
    int on_free_store;
    // ...
public:
    X();
    X(int i);
    ~X();
    // ...
}
```

Every constructor needs code to determine when to use the user-defined allocation strategy:

```
X::X() {
    if (this == 0) {          // 'new' used
        this = myalloc(sizeof(X));
        on_free_store = 1;
    }
    else {                   // static, automatic, or member of aggregate
        this = this;        // forget this assignment at your peril
        on_free_store = 0;
    }
    // initialize
}
```

The assignments to `this` are “magic” in that they suppress the usual compiler generated allocation code.

Similarly, the destructor needs code to determine when to use the user-defined de-allocation strategy and use an assignment to `this` to indicate that it has taken control over deallocation:

```

X::~~X() {
    // cleanup
    if (on_free_store) {
        myfree(this);
        this = 0;    // forget this assignment at your peril
    }
}

```

This user-defined allocation and de-allocation strategy isn't inherited by derived classes in the usual way.

The fundamental problem with the "assign to this" approach to user-controlled memory management is that initialization and memory management code are intertwined in an ad hoc manner. In particular, this implies that the language cannot provide any help with these critical activities.

### Class-Specific Free Store Management

The alternative is to overload the allocation function operator `new()` and the deallocation function operator `delete()` for a class `X`:

```

class X {
    // ...
public:
    void* operator new(size_t sz) { return myalloc(sz); }
    void operator delete(X* p) { myfree(p); }

    X() { /* initialize */ }
    X(int i) { /* initialize */ }

    ~X() { /* cleanup */ }

    // ...
};

```

The type `size_t` is an implementation defined integral type used to hold object sizes<sup>4</sup>. It is the type of the result of `sizeof`.

Now `X::operator new()` will be used instead of the global operator `new()` for objects of class `X`. Note that this does not affect other uses of operator `new` within the scope of `X`:

```

void* X::operator new(size_t s)
{
    void* p = new char[s]; // global operator new as usual
    //...
    return p;
}

void X::operator delete(X* p)
{
    //...
    delete (void*) p; // global operator delete as usual
}

```

When the `new` operator is used to create an object of class `X`, `operator new()` is found by a lookup starting in `X`'s scope so that `X::operator new()` is preferred over a global `::operator new()`.

### Inheritance of operator new()

The usual rules for inheritance apply:

```

class Y : public X // objects of class Y are also allocated
{ // using X::operator new
    // ...
};

```

This is the reason `X::operator new()` needs an argument specifying the amount of store to be allocated; `sizeof(Y)` is typically different from `sizeof(X)`. Naturally, a class that is never a base class need not use the size argument:

```

void* Z::operator new(size_t) { return next_free_Z(); }

```

This optimization should not be used unless the programmer is perfectly sure that `Z` is never used as a base class because if it is disaster will happen.

An `operator new()`, be it local or global, is used only for free store allocation so

```

X a1; // allocated statically

void f()
{
    X a; // allocated on the stack
    X v[10]; // allocated on the stack
}

```

does not involve any `operator new()`. Instead, store is allocated statically and on the stack.

`X::operator new()` is only used for individual objects of class `X` (and objects of classes derived from class `X` that do not have their own `operator new()`) so



```
X* p = new X[10];
```

does not involve `X::operator new()` because `X[10]` is an array.

Like the global operator `new()`, `X::operator new()` returns a `void*`. This indicates that it returns uninitialized memory. It is the job of the compiler to ensure that the memory returned by this function is converted to the proper type and — if necessary — initialized using the appropriate constructor. This is exactly what happens for the global operator `new()`.

`X::operator new()` and `X::operator delete()` are static member functions. In particular, they have no `this` pointer. This reflects the fact that `X::operator new()` is called before constructors so that initialization has not yet happened and `X::operator delete()` is called after the destructor so that the memory no longer holds a valid object of class `X`.

### Overloading operator `new()`

Like other functions, operator `new()` can be overloaded. Every operator `new()` must return a `void*` and take a `size_t` as its first argument. For example:

```
void* operator new(size_t sz); // the usual allocator

void* operator new(size_t sz, heap* h) // allocate from heap 'h'
{
    return h->allocate(sz);
}

void* operator new(size_t, void* p) // place object at 'p'
{
    return p;
}
```

The `size` argument is implicitly provided when operator `new` is used. Subsequent arguments must be explicitly provided by the user. The notation used to supply these additional arguments is an argument list placed immediately after the `new` operator itself:

```
static char buf [sizeof(X)];    // static buffer

class heap {
    // ...
};

heap h1;

f() {
    X* p1 = new X;                // use the default allocator
                                // operator new(size_t sz):
                                // operator new(sizeof(X))

    X* p3 = new(&h1) X;          // use h1's allocator
                                // operator new(size_t sz, heap* h):
                                // operator new(sizeof(X), &h1)

    X* p2 = new(buf) X;         // explicit allocation in 'buf'
                                // operator new(size_t, void* p):
                                // operator new(sizeof(X), buf)
}
```

Note that the explicit arguments go after the new operator but before the type. Arguments after the type goes to the constructor as ever. For example:

```
class Y {
    void* operator new(size_t, const char*);
    Y(const char*);
};

Y* p = new("string for the allocator") Y("string for the constructor");
```

## Controlling Deallocation

Where many different `operator new()` functions are used one might imagine that one would need many different and matching `operator delete()` functions. This would, however, be quite inconvenient and often unmanageable. The fundamental difference between creation and deletion of objects is that at the point of creation the programmer knows just about everything worth knowing about the object whereas at the point of deletion the programmer holds only a pointer to the object. This pointer may not even give the exact type of the object, but only a base class type. It will therefore typically be unreasonable to require the programmer writing a `delete` to choose among several variants<sup>5</sup>.

Consider a class with two allocation functions and a single deallocation function that chooses the proper way of deallocating based on information left in the object by the allocators:

```

class X {
    enum { somehow, other_way } which_allocator;

    void* operator new(size_t sz)
    {
        void* p = allocate_somehow();
        ((X*)p)->which_allocator = somehow;
        return p;
    }

    void* operator new(size_t sz , int i)
    {
        void* p = allocate_some_other_way();
        ((X*)p)->which_allocator = other_way;
        return p;
    }

    void operator delete(void*);
    // ...
};

```

Here `operator delete()` can look at the information left behind in the object by the `operator new()` used and deallocate appropriately:

```

void X::operator delete(void* p)
{
    switch (((X*)p)->which_allocator) {
        case somehow:
            deallocate_somehow();
            break;
        case other_way:
            deallocate_some_other_way();
            break;
        default:
            /* something is funny */
    }
}

```

Since `operator new()` and `operator delete()` are static member functions they need to cast their "object pointers" to use member names. Furthermore, these functions will be invoked only by explicit use of operators `new` and `delete`. This implies that `X::which_allocator` is not initialized for automatic objects so in that case it may have an arbitrary value. In particular, the default case in `X::operator delete()` might occur if someone tried to `delete` an automatic (on the stack) object.

Where (as will often be the case) the rest of the member functions of `X` have no need for examining the information stored by allocators for use by the deallocator this information can be placed in storage outside the object proper ("in the container itself") thus decreasing the memory requirement for automatic and static objects of class `X`. This is exactly the kind of game played by "ordinary" allocators such as the C `malloc()` for managing free store.

The example of the use of assignment to `this` above contains code that depends on knowing whether the object was allocated by `new` or not. Given local allocators and deallocators, it is usually neither wise nor necessary to do so. However, in a hurry or under serious compatibility constraints, one might use a technique like this:

```
class X {
    static X* last_X;
    int on_free_store;
    // ...

    X();

    void* operator new(long s)
    {
        return last_X = allocate_somewhat();
    }

    // ...
};

X::X()
{
    if (this == last_X) { // on free store
        on_free_store = 1;
    }
    else { // static or automatic or member of aggregate
        on_free_store = 0;
    }
    // ...
}
```

Note that there is no simple and implementation independent way of determining that an object is allocated on the stack. There never was.

## Placement of Objects

For ordinary functions it is possible to specifically call a non-member version of the function by prefixing a call with the scope resolution operator `::`. For example,

```
::open(filename, "rw");
```

calls the global `open()`. Prefixing a use of the `new` operator with `::` has the same effect for `operator new()`; that is,

```
X* p = ::new X;
```

uses a global `operator new()` even if a local `X::operator new()` has been defined. This is useful for placing objects at specific addresses (to cope with memory mapped I/O, etc.) and for implementing container classes that manage storage for the objects they maintain. Using `::` ensures that local allocation functions are not used and the argument(s) specified for `new` allows selection among several global `operator new()` functions. For example:

```

// place object at address p:
void* operator new(size_t, void* p) { return p; }

char buf [sizeof(X)];           // static buffer

f()
{
    X* p = ::new(buf) X;         // explicit allocation in 'buf'
    p = ::new((void*)0777) X;   // place an X at address 0777
}

```

Naturally, for most classes the `::` will be redundant since most classes do not define their own allocators. The notation `::delete` can be used similarly to ensure use of a global deallocator.

## Memory Exhaustion

Occasionally, an allocator fails to find memory that it can return to its caller. If the allocator must return in this case, it should return the value 0. A constructor will return immediately upon finding itself called with `this==0` and the complete `new` expression will yield the value 0. In the absence of more elegant error handling schemes, this enables critical software to defend itself against allocation problems. For example:

```

void f()
{
    X* p = new X;
    if (p == 0) { /* handle allocation error */ }
    // use p
}

```

The use of a `new_handler` can make most such checks unnecessary.

## Explicit Calls of Destructors

Where an object is explicitly "placed" at a specific address or in some other way allocated so that no standard deallocator can be used, there might still be a need to destroy the object. This can be done by an explicit call of the destructor:

```
p->X::~~X();
```

The fully qualified form of the destructor's name must be used to avoid potential parsing ambiguities. This requirement also alerts the user that something unusual is going on. After the call of the destructor, `p` no longer points to a valid object of class `X`.

## Size Argument to operator delete()

Like `X::operator new()`, `X::operator delete()` can be overloaded, but since there is no mechanism for the user to supply arguments to a deallocation function this overloading simply presents the programmer with a way of using the information available in the compiler. `X::operator delete()` can have two forms (only):

```
class X {
    void operator delete(void* p);
    void operator delete(void* p, size_t sz);
    // ...
};
```

If the second form is present it will be preferred by the compiler and the second argument will be the size of the object to the best of the compiler's knowledge. This allows a base class to provide memory management services for derived classes:

```
class X {
    void* operator new(size_t sz);
    void operator delete(void* p, size_t sz);

    virtual ~X();
    // ...
};
```

The use of a virtual destructor is crucial for getting the size right in cases where a user deletes an object of a derived class through a pointer to the base class:

```
class Y : public X {
    // ...
    ~Y();
};

X* p = new Y;
delete p;
```

## Assignment and Initialization

C++ originally had assignment and initialization default defined as bitwise copy of an object. This caused problems when an object of a class with assignment was used as a member of a class that did not have assignment defined:

```

class X {
    // ...
public:
    X& operator=(const X&);
    // ...
};

class Y {
    X a;
    // ...
};

void f()
{
    Y y1, y2;
    // ...
    y1 = y2;
}

```

Assuming that assignment was not defined for `Y`, `y2.a` is copied into `y1.a` with a bitwise copy. This invariably turns out to be an error and the programmer has to add an assignment operator to class `Y`:

```

class Y {
    X a;
    // ...
    const Y& operator=(const Y& arg)
    {
        a = arg.a;
        // ...
    }
};

```

To cope with this problem in general, assignment in C++ is now defined as memberwise assignment of non-static members and base class objects<sup>6</sup>. Naturally, this rule applies recursively until a member of a built-in type is found. This implies that for a class `X`, `X(const X&)` and `const X& X::operator=(const X&)` will be supplied where necessary by the compiler, as has always been the case for `X::X()` and `X::~X()`. In principle every class `X` has `X::X()`, `X::X(const X&)`, and `X::operator=(const X&)` defined. In particular, defining a constructor `X::X(T)` where `T` isn't a variant of `X&` does not affect the fact that `X::X(const X&)` is defined. Similarly, defining `X::operator=(T)` where `T` isn't a variant of `X&` does not affect the fact that `X::operator=(const X&)` is defined.

To avoid nasty inconsistencies between the predefined `operator=()` functions and user defined `operator=()` functions, `operator=()` must be a member function. Global assignment functions, such as `::operator(X&,X&)` are anachronisms and will be disallowed after a decent interval.

Note that since access controls are correctly applied to both implicit and explicit copy operations we actually have a way of prohibiting assignment of objects of a given class `X`:

```

class X {
    // Objects of class X cannot be copied
    // except by members of X
    void operator=(X&);
    X(X&);
    // ...
public:
    X(int);
    // ...
};

void f() {
    X a(1);
    X b = a;           // error: X::X(X&) private
    b = a;           // error: X::operator=(X&) private
}

```

The automatic creation of `X::X(const X&)` and `X::operator=(const X&)` has interesting implications on the legality of some assignment operations. Note that if `X` is a public base class of `Y` then a `Y` object is a legal argument for a function that requires an `X&`. For example:

```

class X { public: int aa; };
class Y : public X { public: int bb; };

void f() {
    X xx;
    Y yy;
    xx = yy;           // ok: a Y is an X
                      //   xx=yy; means xx.operator=(X&yy);
                      //   and is optimized to xx.aa = yy.aa
}

```

Defining assignment as memberwise assignment implies that `operator=()` isn't inherited in the ordinary manner. Instead, the appropriate assignment operator is — if necessary — generated for each class. This implies that the "opposite" assignment of an object of a base class to a variable of a derived class is illegal as ever:

```

void f() {
    X xx;
    Y yy;
    yy = xx;           // error: an X is not a Y
}

```

The extension of the assignment semantics to allow assignment of an object of a derived class to a variable of a public base class had been repeatedly requested by users. The direct connection to the recursive memberwise assignment semantics became clear only through work on the two apparently independent problems.



## Operator ->

Until now `->` has been one of the few operators a programmer couldn't define. This made it hard to create classes of objects intended to behave like "smart pointers." When overloading, `->` is considered a unary operator (of its left hand operand) and `->` is reapplied to the result of executing `operator->()`. Hence the return type of an `operator->()` function must be a pointer to a class or an object of a class for which `operator->()` is defined. For example:

```
struct Y { int m; };

class X {
    Y* p;
    // ...
    Y* operator->() {
        if (p == 0) {
            // initialize p
        }
        else {
            // check p
        }
        return p;
    }
    // ...
};
```

Here, class `X` is defined so that objects of type `X` act as pointers to objects of class `Y`, except that some suitable computation is performed on each access.

```
void f(X x, X& xr, X* xp)
{
    x->m;           // x.p->m
    xr->m;         // xr.p->m
    xp->m;         // error: X does not have a member m
}
```

Like `operator=()`, `operator[]()`, and `operator()()`, `operator->()` must be a member function (unlike `operator+()`, `operator-()`, `operator<()`, etc., which are often most useful as friend functions).

The dot operator still cannot be overloaded.

For ordinary pointers, use of `->` is synonymous with some uses of unary `*` and `[]`. For example, for

```
Y* p;
```

it holds that:

$$p \rightarrow m == (*p) . m == p[0] . m$$

As usual, no such guarantee is provided for user-defined operators. The equivalence can be provided where desired:

```

class X {
    public:
        Y* p;
        Y* operator->() { return p; }
        Y& operator*() { return *p; }
        Y& operator[](int i) { return p[i]; }
};

```

If you provide more than one of these operators it might be wise to provide the equivalence exactly as it is wise to ensure that `x+=1` has the same effect as `x=x+1` for a simple variable `x` of some class if `+=`, `=`, and `+` are provided.

The overloading of `->` is important to a class of interesting programs, just like overloading `[]`, and not just a minor curiosity. The reason is that *indirection* is a key concept and that overloading `->` provides a clean, direct, and efficient way of representing it in a program. Another way of looking at operator `->` is to consider it a way of providing C++ with a limited, but very useful, form of *delegation*.

## Operator ,

Until now the comma operator `,` has been one of the few operators a programmer couldn't define. This restriction did not appear to have any purpose so it has been removed. The most obvious use of an overloaded comma operator is list building:

```

class Xlist {
    // ...
    public:
        Xlist();
        Xlist(X&);
        Xlist& operator,(X&);
        friend Xlist operator,(X&,X&);
};

void f()
{
    X a,b,c;
    Xlist xl = (a,b,c);    // meaning operator,(a,b).operator,(c)
}

```

If you have a bit of trouble deciding which commas mean what in this example you have found the reason overloading of comma was originally left out.

## Initialization of static Objects

In C, a static object can only be initialized using a slightly extended form of constant expressions. In C++, it has always been possible to use completely general expressions for the initialization of static class objects. This feature has now been extended to static objects of all types. For example:

```
#include <math.h>

double sqrt2 = sqrt(2);

main()
{
    if (sqrt(2) != sqrt2) abort();
}
```

Such dynamic initialization is done in declaration order within a file and before the first use of any object or function defined in the file. No order is defined for initialization of objects in different source files except that all static initialization takes place before any dynamic initialization.

## Resolutions

This section does not describe additions to C++ but gives answers to questions that have been asked often and do not appear to have clear enough answers in the reference manual of *The C++ Programming Language*. These resolutions involve slight changes compared to earlier rules. This was done to bring C++ closer to the ANSI C draft.

### Function Argument Syntax

Like the C syntax, the C++ syntax for specifying types allows the type `int` to be implicit in some cases. This opens the possibility of ambiguities. In argument declarations, C++ chooses the longest type possible when there appears to be a choice:

```
typedef long I;
f1(const I);      // f1() takes an unnamed 'const long' argument
f2(const i);      // f2() takes a 'const int' argument (called 'i')
```

This rule applies to the `const` and `volatile` specifiers, but not to `unsigned`, `short`, `long`, or `signed`<sup>7</sup>:

```
f3(unsigned int I);      // ok
f4(unsigned I);          // ok: equivalent to f4(unsigned int I);
```

A type cannot contain two basic type specifiers so

```
f5(char I) { I++; }
f6(I I) { I++; }
```

are legal.

## Declaration and Expression Syntax

There is an ambiguity in the C++ grammar involving *expression-statements* and *declarations*: An *expression-statement* with a "function style" explicit type conversion as its leftmost sub-expression can be indistinguishable from a *declaration* where the first *declarator* starts with a (. For example:

```
T(a);           //declaration or type conversion of 'a'
```

In those cases the *statement* is a *declaration*.

To disambiguate, the whole *statement* may have to be examined to determine if it is an *expression-statement* or a *declaration*. This disambiguates many examples. For example, assume T is the name of some type:

```
T(a)->m = 7;           // expression-statement
T(a)++;               // expression-statement
T(a,5)<<c;             // expression-statement
T(*d)(double(3));    // expression-statement
```

```
T(*e)(int);          // declaration
T(f)[];              // declaration
T(g)={ 1,2 };        // declaration
```

The remaining cases are *declarations*. For example:

```
T(a);                // declaration
T(*b)();             // declaration
T(c)=7;              // declaration
T(d),e,f=3;         // declaration
T(g)(h,2);           // declaration
```

The disambiguation is purely syntactic; that is, the meaning of the names, beyond whether they are names of types or not, is not used in the disambiguation.

This resolution has two virtues compared to alternatives: It is simple to explain and completely compatible with C. The main snag is that it is not well adapted to simple minded parsers, such as YACC, because the lookahead required to decide what is an *expression-statement* and what is a *declaration* in a statement context is not limited.

However, note that a simple lexical lookahead can help a parser disambiguate most cases. Consider analyzing a *statement*; the troublesome cases look like this:

```
T ( d-or-e ) tail
```

Here, *d-or-e* must be a *declarator*, an *expression*, or both for the statement to be legal. This implies that *tail* must be a semicolon, something that can follow a parenthesized *declarator* or something that can follow a parenthesized *expression*. That is, an *initializer*, *const*, *volatile*, *(*, or *[* or a postfix or infix operator.

A user can explicitly disambiguate cases that appear obscure. For example:

```

void f()
{
    auto int(*p)(); // explicitly declaration
    (void) int(*p)(); // explicitly expression-statement
    0,int(*p)(); // explicitly expression-statement
    (int(*p)()); // explicitly expression-statement
    int(*p)(); // resolved to declaration
}

```

## Enumerators

An enumeration is a type. Each enumeration is distinct from all other types. The set of possible values for an enumeration is its set of enumerators. The type of an enumerator is its enumeration. For example:

```

enum wine { red, white, rose, bubbly };
enum beer { ale, bitter, lager, stout };

```

defines two types, each with a distinct set of 4 values.

```

wine w = red;
beer b = bitter;

w = b; // error, type mismatch: beer assigned to wine
w = stout; // error, type mismatch: beer assigned to wine
w = 2; // error, type mismatch: int assigned to wine

```

Each enumerator has an integer value and can be used wherever an integer is required; in such cases the integer value is used:

```

int i = rose // the value of 'rose' (that is, 2) is used
i = b; // the value of 'b' is assigned to 'i'

```

This interpretation is stricter than what has been used in C++ until now and stricter than most C dialects. The reason for choosing it was ANSI C's requirement that enumerations be distinct types. Given that, the details follow from C++'s emphasis on type checking and the requirements of consistency to allow overloading, etc. For example:

```

int f(int);
int f(wine);

void g()
{
    f(i);           // f(int)
    f(w);          // f(wine)

    f(1);          // f(int)
    f(white);      // f(wine)

    f(b);          // f(int), standard conversion
                  //           from beer to int used
}

```

C++'s checking of enumerations is stricter than ANSI C's, in that assignments of integers to enumerations are disallowed. As ever, explicit type conversion can be used:

```
w = wine(257);    /* caveat emptor */
```

An enumerator is entered in the scope in which the enumeration is defined. In this context, a class is considered a scope and the usual access control rules apply. For example:

```

class X {
    enum { x, y, z };
    // ...
public:
    enum { a, b, c };

    f(int i = a) { g(i+x); ... }
    // ...
}

void h() {
    int i = a;           // error: 'X::a' is not in scope
    i = X::a;          // ok
    i = X::x;          // error: 'X::x' is private
}

```

## The const Specifier

Use of the `const` specifier on a non-local object implies that linkage is *internal* by default; that is, the object declared is local to the compilation in which it occurs. To give it external linkage it must be explicitly declared `extern`.

Similarly, `inline` implies that linkage is *internal* by default.

External linkage can be obtained by explicit declaration:

```
extern const double g;
const double g = 9.81;

extern inline f(int);
inline f(int i) { return i+c; }
```

## Function Types

It is possible to define function types that can be used exactly like other types, except that variables of function types cannot be defined — only variables of pointer to function types:

```
typedef int F(char*);           // function taking a char* argument
                                // and returning an int
F* pf;                          // pointer to such function
F f;                             // error: no variables of function type allowed
```

Function types can be useful in friend declarations. Here is an example from the C++ task system:

```
class task : public scheduler {
    friend SIG_FUNC_TYP sig_func; // the type of a function must be specified
                                // in a friend function declaration
    // ...
}
```

The reason to use a `typedef` in the friend declaration `sig_func` and not simply to write the type directly is that the type of `signal()` is system dependent:

```
// BSD signal.h:
typedef void SIG_FUNC_TYP(int, int, sigcontext*);

// 9th edition signal.h:
typedef void SIG_FUNC_TYP(int);
```

Using the `typedef` allows the system dependencies to be localized where they belong: in the header files defining the system interface.

## Lvalues

Note that the default definition of assignment of an `X` as a call of

```
X& operator=(const X&)
```

makes assignment of `X`s produce an lvalue. For uniformity, this rule has been extended to assignments of built-in types. By implication, `+=`, `-=`, `*=`, etc., now also produce lvalues. So — again by implication — does prefix `++` and `--` (but not the postfix versions of these operators).

In addition, the comma and `?:` can also produce lvalues. The result of a comma operation is an lvalue if its second operand is. The result of a `?:` operator is an lvalue provided both its second and third operands are and provided they have exactly the same type.

## Multiple Name Spaces

C provides a separate name space for structure tags whereas C++ places type names in the same name space as other names. This gives important notational conveniences to the C++ programmer but severe headaches to people managing header files in mixed C/C++ environments. For example:

```
struct stat {
    // ...
};

extern struct stat(int, struct stat *);
```

was not legal C++ though early implementations accepted it as a compatibility hack. The experience has been that trying to impose the "pure C++" single name space solution (thus outlawing examples such as the one above) has caused too much confusion and too much inconvenience to too many users. Consequently, a slightly cleaned up version of the C/C++ compatibility hack has now become part of C++. This follows the overall principle that where there is a choice between inconveniencing compiler writers and annoying users, the compiler writers should be inconvenienced. It appears that the compromise provided by the rules presented below enables all accepted uses of multiple name spaces in C while preserving the notational convenience of C++ in all cases where C compatibility isn't an essential issue. In particular, every legal C++ program remains legal. The restrictions on the use of constructors and typedef names in connection with the use of multiple name spaces are imposed to prevent some nasty cases of hard to detect ambiguities that would cause trouble for the composition of C++ header files.

A typedef can declare a name to refer to the same type more than once. For example:

```
typedef struct s { /* ... */ } s;
typedef s s;
```

A name *s* can be declared as a type (struct, class, union, enum) *and* as a non-type (function, object, value, etc.) in a single scope. In this case, the name *s* refers to the non-type and `struct s` (or whatever) can be used to refer to the type. The order of declaration does not matter. This rule takes effect only after both declarations of *s* have been seen. For example:

```
struct stat { /* ... */ };
stat a;
void stat(stat* p);
struct stat b;           // struct is needed to avoid the function name
stat(0);                 // function call

int f(int);
f(1);
struct f { /* ... */ };
struct f a;              // struct is needed to avoid the function name
```

A name cannot simultaneously refer to two types:



```

struct s { /* ... */ };
typedef int s;                // error

```

The name of a class with a constructor cannot also simultaneously refer to something else:

```

struct s { s(); /* ... */ };
int s();                      // error

```

```

struct t* p;
int t();                      // ok
int i = t();
struct t { t(); /* ... */ }  // error
i = t();

```

If a non-type name `s` hides a type name `s`, `struct s` can be used to refer to the type name. For example:

```

struct s { /* ... */ };
f(int s) { struct s a; s++; }

```

Note: If a type name hides a non-type name the usual scope rules apply:

```

int s;
f()
{
    struct s { /* ... */ }; // new 's' refers to the type
                           // and the global int is hidden
    s a;
}

```

Use of the `::` scope resolution operator implies that its argument is a non-type name. For example:

```

int s;
f()
{
    struct s { /* ... */ };
    s a;
    ::s = a;
}

```

## Function Declaration Syntax

To ease use of common C++ and ANSI C header files, `void` may be used to indicate that a function takes no arguments:

```

extern int f(void);          // same as ``extern int f();''

```

## Conclusions

C++ is holding up nicely under the strain of large scale use in a diverse range of application areas. The extensions added so far have been relatively easy to integrate into the C++ type system. The C syntax, especially the C declarator syntax, has consistently caused much greater problems than the C semantics; it remains barely manageable. The stringent requirements of compatibility and maintenance of the usual run-time and space efficiencies did not constrain the design of the new features noticeably. Except for the introduction of the keywords **catch**, **private**, **protected**, **signed**, **template**, and **volatile**, the extensions described here are upward compatible. Users will find, however, that type-safe linkage, improved enforcement of **const**, and improved handling of ambiguities will force modification of some programs by detecting previously uncaught errors.

---

## Footnotes

1. Surprisingly, giving character constants type `char` does not cause incompatibilities with C where they have type `int`. Except for the pathological example `sizeof('a')`, every construct that can be expressed in both C and C++ gives the same result. The reason for the surprising compatibility is that even though character constants have type `int` in C, the rules for determining the values of such constants involves the standard conversion from `char` to `int`.
2. The strategy for dealing with ambiguities in inheritance DAGs is essentially the same as the strategy for dealing with ambiguities in expression evaluation involving overloaded operators and user-defined coercions. Note that the access control mechanism does not affect the ambiguity control mechanism. Had `B::f()` been `private` the call `p->f()` would still be ambiguous.
3. Virtual base classes force a modification to this rule; see below.
4. `operator new()` used to require a `long`; `size_t` was adopted to bring C++ allocation mechanisms into line with ANSI C.
5. The requirement that a programmer must distinguish between `delete p` for an individual object and `delete[n] p` for an array is an unfortunate hack and is mitigated only by the fact that there is nothing that forces a programmer to use such arrays.
6. One could argue that the original definition of C++ was inconsistent in requiring bitwise copy of objects of class `Y`, yet guaranteeing that `X::operator=()` would be applied for copying objects of a class `X`. In this case both guarantees cannot be fulfilled.
7. This resolution involves a slight change compared to earlier rules. This was done to bring this aspect of C++ into line with the ANSI C draft.



---

# 2 An Introduction to C++

---

---

<b>An Introduction to C++</b>	2-1
-------------------------------	-----

---

<b>A C++ Example</b>	2-3
Data Abstraction	2-4
Specifications and Implementations	2-5

---

<b>The Specification</b>	2-7
Classes	2-7
Encapsulation	2-8
Member Functions	2-9
Function Argument Type Checking	2-10
Function Name Overloading	2-10
Calling Member Functions	2-11
Constructors	2-11
Constructors and Type Conversion	2-12
Constructors and Initialization	2-12
Operator Overloading	2-12
Destructors	2-13
Summary	2-14

---

<b>The Implementation</b>	2-15
The <b>BigInt(const char*)</b> Constructor	2-15
The Scope Resolution Operator	2-16
Constant Types	2-16
Member Variable References	2-16
The <b>new</b> Operator	2-16
Placement of Declarations	2-17
The <b>BigInt(int)</b> Constructor	2-17
The Initialization Constructor	2-18
References	2-18
The Addition Operator	2-19
The <b>BigInt(char*,int)</b> constructor	2-20
Class <b>DigitStream</b>	2-21
Friend Functions	2-22
The Keyword <b>this</b>	2-23
The Member Function <b>BigInt::print()</b>	2-23
The <b>BigInt</b> Destructor	2-23
Inline Functions	2-24
Summary	2-25

---

<b>Other Uses for Abstract Data Types</b>	2-26
Dynamic Character Strings	2-26
Complex Numbers	2-26
Vectors	2-26
Stream I/O	2-26
<hr/>	
<b>Object-Oriented Programming in C++</b>	2-28
Derived Classes	2-28
Virtual Functions	2-28
Class Libraries	2-31
Object I/O	2-33
<hr/>	
<b>The Current Status of C++</b>	2-36
<hr/>	
<b>The Future of C++</b>	2-37
<hr/>	
<b>Footnotes</b>	2-38

---

# An Introduction to C++

**NOTE**

This chapter is taken directly from a paper by Keith Gorlen.

The C++ programming language was designed and implemented by Bjarne Stroustrup of AT&T Bell Laboratories as a successor to C<sup>1</sup>. It retains compatibility with existing C programs and the efficiency of C. It also adds many powerful new capabilities, making it suitable for a wide range of applications from device drivers to artificial intelligence. C++ will be of interest to UNIX users because of its intimate relation to C and its potential use for building graphical user interfaces to UNIX, for UNIX systems programming, and for supporting large-scale software development under UNIX.

C++ evolved from a dialect of C known as "C with Classes," which was invented in 1980 as a language for writing efficient event-driven simulations. Several key ideas were borrowed from the Simula67 and Algol 68 programming languages. Figure 2-1 shows the heritage of C++.

---

**Figure 2-1: The Heritage of C++**

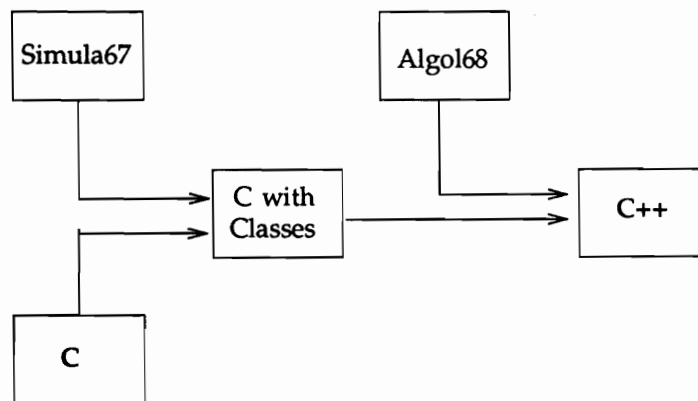

---

The definitive book on C++ is Bjarne Stroustrup's *The C++ Programming Language*, which gives a detailed description of the language and contains many examples and exercises. It also includes the C++ reference manual, which is a concise, more formal definition of the language.

In this chapter, we'll see how C++ corrects most of the deficiencies of C by offering improved compile-time type checking and support for encapsulation. We'll also introduce you to many of the new features of C++:

- classes
- type checking
- operator and function name overloading
- free store management

- constant types
- references
- inline functions
- derived classes
- virtual functions

We'll present these features in the context of a non-trivial example so that you'll understand the motivation behind them and see how they are typically used.

By the end of the paper, you'll see how proper use of C++ can dramatically increase a programmer's productivity. C++ programs are shorter, clearer, and more likely to be correct from the outset. As a result, they are also easier to debug and to maintain.

We'll conclude the paper by discussing the current status and future of C++.



---

## A C++ Example

The best way to learn about C++ is to write a program in it, and that is what we'll do in the next three sections. Let's start in familiar territory by taking a look at a simple program written in plain old C:

```
main()
{
    int a = 193;
    int b = 456;
    int c = a + b + 47;
    printf("%d\n", c);
}
```

This program declares three integer variables named `a`, `b`, and `c`, initializing `a` and `b` to the values 193 and 456, respectively. The integer `c` is initialized to the result of adding `a` and `b` and the constant 47. Finally, the standard C library function `printf()` is called to print out the value of `c`. The quoted string `"%d\n"` tells how to print the result: `%d` prints `c` as a decimal number, and `\n` adds a newline character. If we compile and execute this program, it prints out the number 696 and exits.

Now suppose we wish to perform a similar calculation, but this time `a` and `b` are big numbers, like the U. S. national debt expressed in dollars. Such numbers are too big to be stored as ints on most computers, so if we tried to write `int a = 25123654789456` the C compiler (hopefully!) would give us an error message and fail to compile the program. There are many practical applications for big integers, such as cryptography, symbolic algebra, and number theory, where it can be necessary to perform arithmetic on numbers with hundreds or even thousands of digits.

It isn't easy to write a program to deal with these big numbers in ordinary C. Coding and debugging the algorithms that perform arithmetic operations on big integers in C involves a significant amount of work, so we'd want to make them general-purpose. We wouldn't be able to predict how big the numbers might become in advance, so we would have to use a dynamic memory allocator to manage their storage at execution time. We'd need to write a C library of functions for creating, destroying, reading, printing, assigning, and performing basic arithmetic on big integers. These functions would have to have distinctive names such as `create_bigint`, `print_bigint`, and `add_bigints` to avoid confusion with other kinds of data that we might want to create, print, or add in the same program.

Worst of all, programmers wishing to use our big integers would have to know the names of these functions and the rules for calling them. They would have to remember to create and initialize big integers when they needed to use them, and to destroy them when they were finished. Even simple arithmetic expressions would be awkward to write; `c = a+b` would have to be coded as:

```
assign_bigint (&c, add_bigints (a, b))
```

and there might be problems with handling temporary results calculated during the evaluation of a complex expression. Also, programmers would have to be careful when combining big integers with other data types such as `int`. They would need to call a function to convert ints to big integers before adding them, for example. Any C program using big integers would be both difficult to write and difficult to read.

In C++, we still must write the code to manage the storage of big integers and functions to perform the same operations on them. The difference is that C++ lets us "package" this code so that using our big integers is as convenient as using the `int` data type that is built into C. We can, in effect, extend the C++ language by adding our own custom data type, which we'll call `BigInt`. Notice how similar the example C program is to this C++ program which performs a similar calculation using `BigInts`

instead of ints:

```
#include "BigInt.h"
main()
{
    BigInt a = "25123654789456";
    BigInt b = "456023398798362";
    BigInt c = a + b + 47;
    c.print(); /* print the result, c */
    printf("\n");
}
```

## Data Abstraction

This technique of defining new data types that are well-suited to the application to be programmed is known as *data abstraction*, and a data type such as **BigInt** is called an *abstract data type*. Data abstraction is a powerful, general-purpose technique which, when properly used, can result in shorter, more readable, more flexible programs.

Data abstraction is supported by several other modern programming languages such as Ada.

In these languages, and in C++ as well, a programmer can define a new abstract data type by specifying a data structure together with the operations permissible on that data structure, as shown in Figure 2-2.

---

Figure 2-2: An Abstract Data Type

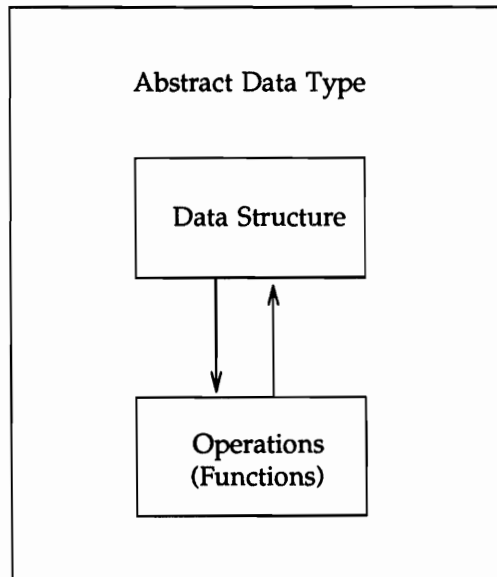

It is difficult or impossible to practice data abstraction in most other programming languages currently in widespread use, such as BASIC, C, COBOL, FORTRAN, PASCAL, or Modula-2. This is because data abstraction requires special language features not available in these languages. To get an idea of what these features do, let's analyze the example C++ program.

The first three statements in the body of the `main()` program declare three type `BigInt` variables, `a`, `b`, and `c`. The C++ compiler needs to know how to create them — how much space to allocate for them and how to initialize them.

The first and second statements are similar; they initialize the `BigInt` variables `a` and `b` with big integer constants written as character strings containing only digits. To do this the C++ compiler must be able to convert character strings into `BigInts`.

The third statement is the most complicated. It adds `a`, `b`, and the integer constant 47 and stores the result in `c`. The C++ compiler needs to be able to create a temporary `BigInt` variable to hold the sum of `a` and `b`. Then it must convert the `int` constant 47 into a `BigInt` and add this to the temporary variable. Finally, it must initialize `c` from this temporary `BigInt` variable.

The fourth statement prints `c` on the standard output, and the last statement calls the C library function `printf()` to print a newline character. C programmers are probably familiar with `printf()`, but `c.print()` probably looks a bit strange. It is a call on a special kind of function available in C++ called a *member function*. We'll talk more about this later, but for now just think of it as a function that prints out a variable of type `BigInt`.

Even though there are no more statements in the body of `main()`, the compiler isn't finished yet. It must destroy the `BigInt` variables `a`, `b`, and `c` and any `BigInt` temporaries it may have created before leaving a function, such as `main()`. This is to assure that the storage used by these variables is freed.

Let's summarize what the C++ compiler needs to know how to do with `BigInts` to compile the example program:

- *create* new instances of `BigInt` variables
- *convert* character strings and integers to `BigInts`
- *initialize* the value of one `BigInt` with that of another `BigInt`
- *add* two `BigInts` together
- *print* `BigInts`
- *destroy* `BigInts` when they are no longer needed

## Specifications and Implementations

Where does the C++ compiler obtain this know-how? From the file `BigInt.h`, which is included by the first line of the example program. This file contains the *specification* of our `BigInt` abstract data type. The specification contains the information that programs that *use* an abstract data type need to have to be successfully compiled. The details of *how* the abstract data type works, known as the *implementation*, are kept in another file. In our example, this file is named `BigInt.c`. It is compiled separately, and the object code produced from it is linked with the program that uses the abstract data type, also called the *client* program. Figure 2-3 shows how the specification and implementation of an abstract data type are combined with the source code of a client program to produce an executable program.

Figure 2-3: Combining the specification (BigInt.h) and implementation (BigInt.c) of an abstract data type (BigInt) with the source code of a client program (client.c) to produce an executable program(client).

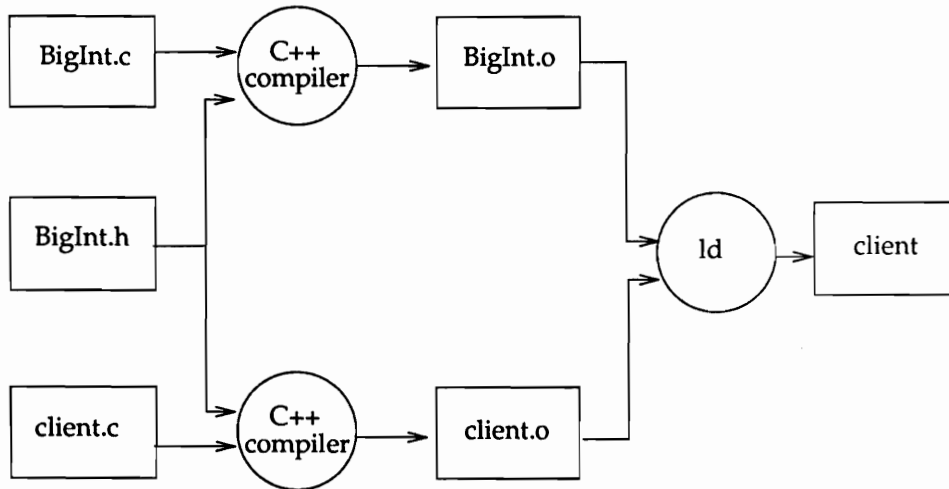

---

We separate the code for an abstract data type into a specification part and an implementation part to hide the implementation details from the client. We can then change the implementation and be confident that client programs will continue to work correctly after they are relinked with the modified object code. This is useful when a team of programmers work on a large software project. Once they agree on the specifications for the abstract data types they need, each team member can implement one or more of them independently of the rest of the team.

A well-designed abstract data type also hides its complexity in its implementation, making it as easy as possible for clients to use.

---

## The Specification

Let's take a look at the specification for our `BigInt` data type, contained in the file `BigInt.h`. (Note that in C++, `//` begins a comment that extends to the end of the line.)

```
class BigInt {
    char* digits;           // pointer to digit array in free store
    int ndigits;           // number of digits
public:
    BigInt(const char*);   // constructor function
    BigInt(int);           // constructor function
    BigInt(const BigInt&); // initialization constructor function
    BigInt operator+(const BigInt&); // addition operator function
    void print();         // printing function
    ~BigInt();            // destructor function
};
```

Much of this code may look odd, but we'll explain it as we cover the features of C++ in the next few sections.

## Classes

This is an example of one of the most important features of C++, the class declaration, which specifies an abstract data type. It is an extension of something C programmers are probably already familiar with: the `struct` declaration.

The `struct` declaration groups together a number of variables, which may be of different types, into a unit. For example, in C (or in C++) we can write:

```
struct BigInt {
    char* digits;
    int ndigits;
};
```

We can then declare an *instance* of this structure by writing:

```
struct BigInt a;
```

The individual *member variables* of the `struct`, `digits` and `ndigits`, can be accessed using the dot (`.`) operator; for example, `a.digits`, accesses the member variable `digits` of the `struct a`.

Recall that in C we can also declare a pointer to an instance of a structure:

```
struct BigInt* p;
```

in which case we can access the individual member variables by using the `->` operator; for example, `p->digits`.

C++ classes work in a similar manner, and the `.` and `->` operators are used in the same way to access a class's member variables. In our example, class `BigInt` has two member variables named `digits` and `ndigits`. The variable `digits` points to an array of bytes (`chars`), allocated from the free storage area, that holds the digits of the big integer, one decimal digit per byte. The digits are ordered beginning with the least significant digit in the first byte of the array. The member variable `ndigits` contains the number of digits in the integer. Figure 2-4 shows a diagram of this data structure for the number 654321.

Figure 2-4: A diagram of the `BigInt` data structure for the number 654321

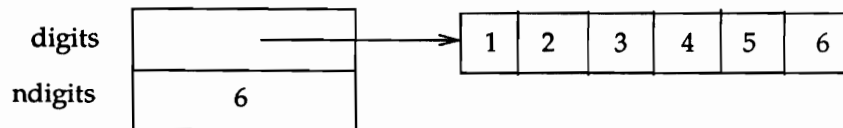

---

However, the C++ class can do much more than the `struct` feature of regular C. We'll now look at these extensions in detail.

## Encapsulation

In C++, a client program can declare an instance of class `BigInt` by writing:

```
BigInt a;
```

But now we have a potential problem: the client program might try, for example, to use the fact that `a.ndigits` contains the number of digits in the number `a`. This would make the client program dependent on the *implementation* of class `BigInt` — after all, we might wish to change the representation of `BigInts` to use hexadecimal instead of decimal arithmetic to save storage. We need a way to prevent unauthorized access to the member variables of the instances of a class. C++ provides this by allowing the use of the keyword `public`: within a class declaration to indicate which members can be accessed by anyone and which have restricted access. Members declared before the `public`: keyword are *private*, as are `digits` and `ndigits` in this example, so C++ will issue an error message if a client program attempts to use them.

Protecting the member variables of a class in this manner is known as *encapsulation*. It is a good programming practice because it enforces the separation between the specification and the implementation of abstract data types that we are trying to achieve, and it helps when debugging programs. For example, if we find that `ndigits` has the wrong value in some situation, those parts of the program that do not have access to the variable are probably not at fault.

## Member Functions

But how does a client program interact with the private member variables of a class? Whereas a struct allows only variables to be grouped together, the C++ class declaration allows both variables and the functions that operate on them to be grouped. Such functions are called *member functions*, and the private member variables of the instances of a class can be accessed only by the member functions of that class. Thus, a client program can read or modify the values of the private member variables of an instance of a class indirectly, by calling the public member functions of the class, as shown in Figure 2-5.

**Figure 2-5:** Client programs can access the private member variables of an instance of a class only by calling public member functions of the class.

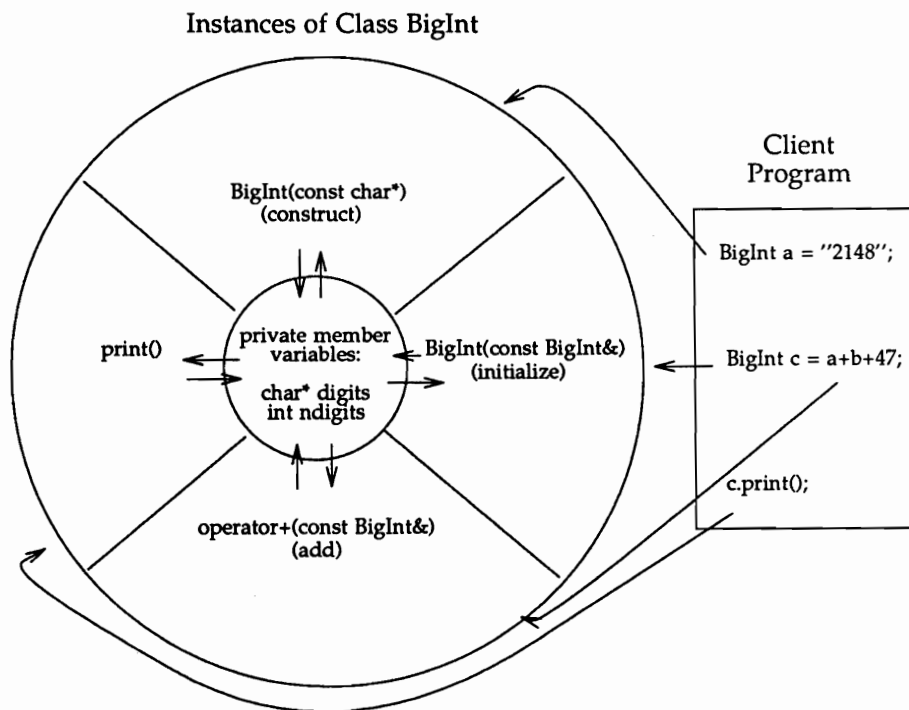

Our example class `BigInt` has two private member variables, `digits` and `ndigits`, and six public member functions. The declarations of these member functions will look unusual to C programmers for several reasons: the types of the arguments of the functions are listed within parentheses in the function declarations, three of the functions declared have the same name, `BigInt`, and the function names `operator+` and `~BigInt` contain characters normally not allowed in function names.

## Function Argument Type Checking

C++ strongly encourages a programmer to declare the types of the arguments of all functions. This makes it possible for C++ to check for inconsistent argument types when a function call is compiled, and can eliminate many bugs at an early stage. For example, the C statement:

```
fprintf("The answer is %d",x);
```

will compile with no problem. However, when this statement is executed the program will abort with a cryptic error message. The problem is that the standard C library function `fprintf()` expects the first argument to be a pointer to the stream to which the output is to be written, not a format string as it is here. On the other hand, in C++ we can declare the argument types of `fprintf()`:

```
extern int fprintf(FILE*, const char*, ...);
```

so the compiler can give us an error message when we try to compile the incorrect function call, noting the discrepancy in the argument types. Conveniently, the argument types for most standard library functions are declared in system header files that you can include in your programs so that you don't have to write all these common declarations yourself.

## Function Name Overloading

Listing the types of all of a function's arguments in its declaration has a second benefit: we can define several functions with the same name, as long as each requires a different number and/or type of argument. For example, in C++ we can declare two functions with the name `abs`:

```
int abs(int);  
float abs(float);
```

We can then write:

```
x = abs(2);  
y = abs(3.14);
```

The first statement will call `abs(int)`, and the second will call `abs(float)` — the C++ compiler knows which `abs` to use because `2` is an `int` and `3.14` is a `float`. When more than one function has the same name like this, the name is said to be *overloaded*. One advantage of overloading is that it eliminates "funny" function names (remember `ABS`, `IABS`, `DABS`, and `CABS` from FORTRAN?). It also leads to more general programs; for example, we can write `copy(x,y)` to copy a `y` to an `x` without having to worry about their types — they might be arrays, or strings, or files — as long as we have written a `copy` function to handle each case.



## Calling Member Functions

Getting back to our `BigInt` example and our discussion of member functions, we can now explain the next-to-last line in our first C++ program which is:

```
c.print();
```

Member functions are called in a manner analogous to the way member variables are normally accessed in C; that is, by using the `.` or `->` operators. Since `c` is an instance of class `BigInt`, the notation `c.print()` calls the member function `print()` of class `BigInt` to print the current value of `c`. Similarly, if we declared a pointer to a `BigInt`:

```
BigInt* p;
```

then the notation `p->print()` would call the same function. This notation prevents this particular `print()` from inadvertently being called to operate on anything other than an instance of class `BigInt`.

In C++, several different classes may all have member functions with the same name, just as in regular C several different `structs` may all have member variables with the same name. This lets us use simple function names, like `print`, rather than distinctive names, like `print_bigint`, without worrying about naming conflicts. We could add a new class, say `BigFloat`, to a program that also used `BigInts`, and we could also define `print()` as a member function of class `BigFloat`. Our program could contain the statements:

```
BigInt a = "2934673485419";
BigFloat x = "874387430.3945798";
a.print();
x.print();
```

and the C++ compiler would use the appropriate `print()` in both cases.

## Constructors

As you'll recall, one of the things the C++ compiler needs to know about our `BigInt` abstract data type is how to create new instances of `BigInts`. We can tell C++ how we want this done by defining one or more special member functions called *constructors*. A constructor function is one which has the same name as its class. When a client program contains a declaration such as:

```
BigInt a = "123";
```

the C++ compiler reserves space for the member variables of an instance of class `BigInt` and calls the constructor function `a.BigInt("123")`. It is our responsibility as providers of the `BigInt` data type to write the function `BigInt()` so that it initializes the instance correctly. In our example, we'll have `BigInt("123")` allocate three bytes of dynamic storage, set `a.digits` to point to this storage, set the three bytes to `{3,2,1}`, and set `a.ndigits` to three. This will create an instance of class `BigInt` named `a` that is initialized to 123.

If a class has a constructor function, C++ *guarantees* that it will be called to initialize every instance of the class that is created. A user of an abstract data type such as **BigInt** does not have to remember to call an initialization function separately for every **BigInt** declared, thus eliminating a common source of programming errors.

## Constructors and Type Conversion

The second thing C++ needs to know is how to convert something that is a character string, such as "25123654789456", or an integer, such as 47, to a **BigInt**. Constructors are also used for this purpose. When the C++ compiler sees a statement like:

```
BigInt c = a + b + 47;
```

it recognizes that the `int 47` must be converted to a **BigInt** before the addition can be done, and so checks to see if the constructor **BigInt(int)** is declared. If so, it creates a temporary instance of **BigInt** by calling **BigInt(int)** with the argument 47. If an appropriate constructor is not declared, the statement is flagged as an error. We have defined **BigInt(char\*)** and **BigInt(int)** for class **BigInt**, so we may freely use character strings or integers wherever a **BigInt** can be used, and the C++ compiler will automatically call our constructor to do the type conversion. This is an important feature of C++ because it lets us blend our own abstract data types with others and with the fundamental types built into the language.

## Constructors and Initialization

The third thing C++ must know how to do is how to initialize a **BigInt** with the value of another **BigInt**, as is required by a statement such as:

```
BigInt c = a + b + 47;
```

The **BigInt c** must be initialized with the value of a temporary **BigInt** that holds the result of the expression `a + b + 47`.

We can control how C++ initializes instances of class **BigInt** by defining the special constructor function **BigInt(const BigInt&)**. In our example, we'll make this constructor allocate storage for the new instance and make a copy of the contents of the argument instance.

## Operator Overloading

The fourth thing C++ must be able to do is to add two **BigInts**. We could just define a member function named `add` to do this, but then writing arithmetic expressions would be awkward. C++ lets us define additional meanings for most of its operators, including `+`, so we can make it mean "add" when applied to **BigInts**. This is known as *operator overloading*, and is similar to the concept of function name overloading.

Actually, most programmers are already familiar with this idea because the operators of most programming languages, including C, are already overloaded. For example, we can write:

```
int a,b,c;
float x,y,z;
c = a+b;
z = x+y;
```

The operators = and + do quite different things in the last two statements: the first statement does *integer* addition and assignment and the second does *floating point* addition and assignment. Operator overloading is simply an extension of this.

C++ recognizes a function name having the form `operator@` as an overloading of the C++ operator symbol @. We can overload the operator +, for example, by declaring the member function named `operator+`, as we have done in our example class `BigInt`. We can call this function using either the usual notation for calling member functions or by using just the operator:

```
BigInt a,b,c;
c = a.operator+(b);
c = a + b;
```

The last two lines are equivalent.<sup>2</sup>

Of course, if we overload an operator, we don't change its built-in meaning, we only give it an additional meaning when used on instances of our new abstract data type. The expression `2+2` still gives 4.

## Destructors

The last thing we said was that C++ needed to know how to destroy instances of our `BigInts` once it was finished with them. We can tell the C++ compiler how to do this by defining another special kind of member function called a *destructor*. A destructor function has the same name as its class, prefixed by the character `~`. For class `BigInt`, this is the member function `~BigInt()`. Since `~` is the C++ and C complement operator, this naming convention suggests that destructors are complementary to constructors.

We must write the function `~BigInt()` so that it properly cleans-up, or *finalizes* instances of class `BigInt` for which it is called. In our example, this means freeing the dynamic storage that was allocated by the constructor.

If a class has a destructor function, C++ *guarantees* that it will be called to finalize every instance of the class when it is no longer needed. Once again, this relieves users of an abstract data type like `BigInt` from having to remember to do this, and eliminates another source of programming errors.

## Summary

We've covered a lot of territory already, so let's review where we've been.

We've seen how using the technique of data abstraction can lead to more reliable, more readable, and more flexible programs, and we've introduced many of the features of C++ that help us practice data abstraction:

- *classes*, the basic language construct for defining new abstract data types;
- *member variables*, which describe the data in an abstract class, and *member functions*, which define the operations on an abstract class;
- *encapsulation*, which lets us restrict access to certain member variables and functions;
- *function argument type checking*, which helps to ensure that functions are called with proper arguments;
- *function name overloading*, which reduces the need for using unusual function names and helps to generalize code;
- *constructors and destructors*, which manage the storage for an abstract data type and guarantee that instances of an abstract data type are initialized and finalized;
- *user-defined implicit type conversion*, to let us blend our abstract data types with others and with the fundamental data types of the language; and,
- *operator overloading*, to let us give additional meaning to most of the existing operators when used with our own abstract data types, making our new data types easier to use.

We've also introduced the idea of breaking up an abstract data type into its specification, which contains the information that the user, or client, needs to know to use the abstract data type, and its implementation, which hides the details of how the abstract data type works so that it may be programmed independently by a member of a programming team and be easily maintained.

---

## The Implementation

We've just taken a detailed look at the specification of our **BigInt** abstract data type. Now it's time to discuss its implementation.

As we said earlier, the implementation of an abstract data type consists of the C++ code that embodies the details of *how* the data abstraction works. For our example it is kept in a separate file named **BigInt.c**.

The implementation requires the information kept in the specification, so the first line in **BigInt.c** is:

```
#include "BigInt.h"
```

Since both the implementation and client programs are compiled with the same specification, the C++ compiler ensures a consistent interface between them.

### The **BigInt(const char\*)** Constructor

Class **BigInt** has three constructors, one to create an instance of a **BigInt** from a character string of digits (a **char\***), one to create an instance from an integer (an **int**), and one to initialize one **BigInt** from another. We need to be able to create a **BigInt** from a string of digits because this is the only way we can legally write very large integer constants in C++. Creating a **BigInt** from an **int** is provided as a convenience, so we can write small integers in the usual way.

Here is the implementation of the first constructor:

```
BigInt::BigInt(const char* digitString)
{
    int n = strlen(digitString);
    if (n != 0) {
        digits = new char[ndigits=n];
        char* p = digits;
        const char* q = &digitString[n];
        while (n-- *p++ = *--q - '0');
    }
    else { // empty string
        digits = new char[ndigits=1];
        digits[0] = 0;
    }
}
```

This constructor initializes the data structure of a **BigInt** as we described previously. We determine the length of the character string argument, allocate enough memory to hold the digits of the number, then scan the character string from right to left, converting each digit character to its binary representation.

If the character string is empty we treat this as a special case and create a **BigInt** initialized to zero.

C programmers will find this code quite recognizable, with a few exceptions that we'll explain in the next few sections.

## The Scope Resolution Operator

The notation `BigInt::BigInt` identifies `BigInt` as a member function of class `BigInt`. We mentioned earlier that several C++ classes can have member functions with the same names. When it is necessary to specify exactly *which* class member we're dealing with, we can prefix the member name by the class name and the `::` operator. The `::` operator is known as the *scope resolution operator*, and it may be applied to both member functions and member variables.

## Constant Types

C programmers will be familiar with use of the type `char*` for arguments that are character strings, but what is a `const char*`? In C++, the keyword `const` can be used before a type to indicate that the variable being declared is constant, and therefore may not appear to the left of the assignment (`=`) operator. When used in an argument list as it is above, it prevents the argument from being modified by the function. This protects against another kind of common programming error.

## Member Variable References

Throughout the body of the member function, you'll notice that we are able to reference the member variables of the instance for which the function is called without using the `.` or `->` operators, as we did for example in the statement:

```
digits = new char[ndigits=n];
```

Since member functions reference the member variables of their class frequently, this provides a convenient, short notation.

## The new Operator

We used the C++ `new` operator to allocate the dynamic storage needed to hold the digits of a `BigInt`. In C, we would call the standard C library function `malloc()` to do this. The `new` operator has two advantages, however. First, it returns a pointer of the appropriate data type. Thus, to allocate space for the member variables of a `struct BigInt` in C we would write:

```
(struct BigInt*)malloc(sizeof(struct BigInt))
```

whereas in C++ we can write:

```
new BigInt
```

The second advantage is that if we use `new` to allocate an instance of a class having a constructor function (such as `BigInt`), the constructor is called automatically to initialize the newly allocated instance. The result is more readable, less error-prone code.

## Placement of Declarations

C programmers may have noticed that the declaration of `p` seems to be “misplaced”:

```
if (n != 0) {
    digits = new char[ndigits=n];    // a statement
    char* p = digits;                // a declaration!
```

since it appears *after* the first statement in a block. In C++, declarations may be intermixed with statements as long as each variable is declared before its first use. You can frequently improve the readability of a program by placing variable declarations near the place where they are used.

## The BigInt(int) Constructor

Here’s the implementation of the `BigInt(int)` constructor, which creates a `BigInt` from an integer:

```
BigInt::BigInt(int n)
{
    char d[3*sizeof(int)+1];    // buffer for decimal digits
    char* dp = d;              // pointer to next decimal digit
    ndigits = 0;
    do {                        // convert integer to decimal digits
        *dp++ = n%10;
        n /= 10;
        ndigits++;
    } while (n > 0);
    digits = new char[ndigits];
    register int i;
    for (i=0; i<ndigits; i++) digits[i] = d[i];
}
```

This constructor works by converting the integer argument to decimal digits in the temporary array `d`. We then know how much space to allocate for the `BigInt`, so we allocate the correct amount of dynamic storage using the `new` operator, and copy the decimal digits from the temporary array into it.

## The Initialization Constructor

The job of the initialization constructor is to copy the value of its `BigInt` argument into a new instance of `BigInt`:

```
void BigInt::BigInt(const BigInt& n)
{
    int i = n.ndigits;
    digits = new char[ndigits=i];
    char* p = digits;
    char* q = n.digits;
    while (i--) *p++ = *q++;
}
```

This function makes use of a *reference*, an important C++ feature we haven't seen before.

## References

The argument type of the member function `BigInt(const BigInt&)` is an example of a C++ *reference*. References address a serious deficiency of C: the lack of a way to pass function arguments by reference.

To understand what this means, suppose we wish to write a function named `inc()` that adds one to its argument. If we wrote this in C as:

```
void inc(x)
int x;
{
    x++;
}
```

and then called `inc()` with the following program:

```
int y = 1;
inc(y);
printf("%d\n", y);
```

we would discover that the program would print a 1, not a 2. This is because in C the *value* of `y` is copied into the argument `x`, and the statement `x++` increments this copy, leaving the value of `y` unchanged. This treatment of function arguments is known as *call by value*.

To do this correctly in C we must explicitly pass a pointer as the argument to `inc()`:



```

void inc(x)
int* x;
{
    *x++;
}

int y = 1;
inc(&y);
printf("%d\n",y);

```

Notice that we had to change the program in three ways:

- the type of the function argument was changed from an `int` to an `int*`;
- each occurrence of the argument in the body of the function was changed from `x` to `*x`; and,
- each call of the function was changed from `inc(y)` to `inc(&y)`.

The point is that passing a pointer as a function argument requires consistency in every usage of the argument within the function body and, worse yet, in every call of the function made by client programs. This, combined with C's lack of function argument type checking, results in ample opportunity for error.

Using a C++ reference, we can write the function `inc()` as follows:

```

void inc(int& x)
{
    x++;
}

int y = 1;
inc(y);
printf("%d\n",y);

```

This requires changing only the argument type from `int` to `int&`.

In the function `inc()`, we need to pass the argument `x` using a reference because its value is modified by the function. But efficiency is another reason for passing arguments by reference. When the value of an argument requires a lot of storage, as in the case of `BigInts`, it is less expensive to pass a pointer to the argument even though its value is not to be changed. That's why we declared the argument to `BigInt` as `const BigInt&` — the reference `BigInt&` causes just a pointer to the argument to be passed, but the `const` prevents that pointer from being used to change the argument's value from within the function.

## The Addition Operator

Let's take a look at a first draft of the function `operator+`, which implements `BigInt` addition:

```

BigInt BigInt::operator+(const BigInt& n)
{
    // Calculate maximum possible number of digits in sum
    int maxDigits = (ndigits>n.ndigits ? ndigits : n.ndigits)+1;
    char* sumPtr = new char[maxDigits]; // allocate storage for sum
    BigInt sum(sumPtr,maxDigits);      // must define this constructor
    int i = maxDigits;
    int carry = 0;
    while (i-->0) {
        *sumPtr = /*next digit of this*/ + /*next digit of n*/ + carry;
        if (*sumPtr > 9) {
            carry = 1;
            *sumPtr -= 10;
        }
        else carry = 0;
        sumPtr++;
    }
    return sum;
}

```

We add two `BigInt`s by using the paper-and-pencil method we all learned in grammar school: we add the digits of each operand from right to left, beginning with the rightmost, and also add a possible carry in from the previous column. If the sum is greater than nine, we subtract ten from the result and produce a carry.

## The `BigInt(char*,int)` constructor

We ran into a couple of problems when writing the addition function which we indicated with comments in the code. The first problem is that we need to declare an instance of `BigInt` named `sum` in which to place the result of the addition, which will be left in the array pointed to by `sumPtr`. We must use a constructor to create this instance of `BigInt`, but none of those we have defined thus far are suitable, so we must write another.

This new constructor takes a pointer to an array containing the digits and the number of digits in the array as arguments and creates a `BigInt` from them. We don't want our client programs to use such an unsafe and implementation-dependent function, so we'll declare it in the private part of class `BigInt` where it can only be used by member functions. Thus, we add the declaration:

```
BigInt (char*, int);
```

just before the keyword `public`: in the declaration of class `BigInt` in the file `BigInt.h`, and we add the implementation of this constructor to the file `BigInt.c`:

```

BigInt::BigInt(char* d, int n)
{
    digits = d;
    ndigits = n;
}

```

## Class DigitStream

The second problem we encountered is that scanning the digits of the operands in the statement:

```
*sump = /*next digit of this*/ + /*next digit of n*/ + carry;
```

becomes complicated because one of the operands may contain fewer digits than the other, in which case we must pad it to the left with zeros. We would also face this problem when implementing **BigInt** subtraction, multiplication, and division, so it is worthwhile to find a clean solution. Let's use an abstract data type!

Here is the declaration for class **DigitStream** and the implementation of its member functions:

```

class DigitStream {
    char* dp;                // pointer to current digit
    int nd;                  // number of digits remaining
public:
    DigitStream(const BigInt& n); // constructor
    int operator++();           // return current digit and advance
};

DigitStream::DigitStream(BigInt& n)
{
    dp = n.digits;
    nd = n.ndigits;
}

int DigitStream::operator++()
{
    if (nd == 0) return 0;
    else {
        nd--;
        return *dp++;
    }
}

```

We can now declare an instance of a **DigitStream** for each of the operands and use the **++** operator when we need to read the next digit.

With these two problems solved, the implementation of the **BigInt** addition operator looks like:

```

BigInt BigInt::operator+(const BigInt& n)
{
    int maxDigits = (ndigits>n.ndigits ? ndigits : n.ndigits)+1;
    char* sumPtr = new char[maxDigits];
    BigInt sum(sumPtr,maxDigits);
    DigitStream a(*this);
    DigitStream b(n);
    int i = maxDigits;
    int carry = 0;
    while (i-->0) {
        *sumPtr = (a++ + b++) + carry;
        if (*sumPtr > 9) {
            carry = 1;
            *sumPtr -= 10;
        }
        else carry = 0;
        sumPtr++;
    }
    return sum;
}

```

## Friend Functions

Our abstract data type `DigitStream` looks quite elegant, but you may be wondering how the constructor `DigitStream(const BigInt&)` is able to access the member variables `digits` and `ndigits` of class `BigInt`. After all, `digits` and `ndigits` are private, and `DigitStream(const BigInt&)` is not a member function of class `BigInt`.

Well, it can't. We need a way to grant access to these variables to just this one function. C++ provides us with a way to do this — we can make this constructor a *friend* of class `BigInt` by adding the declaration:

```
friend DigitStream::DigitStream(const BigInt&);
```

to the declaration of class `BigInt`.

We can also make *all* of the member functions of one class friends of another by declaring the entire class as a *friend*. For example, we can make *all* of the member functions of class `DigitStream` friends of class `BigInt` by placing the declaration:

```
friend DigitStream;
```

in the declaration of class `BigInt`.

## The Keyword `this`

Going back to the implementation of the function `operator+()`, you may be wondering where the pointer variable `this` came from in the declaration:

```
DigitStream a(*this);
```

Previously, we described how within the body of a member function we could refer to the members of the instance for which the function was called without using the `.` or `->` operators. C++ also gives us the keyword `this` so that we may refer to the entire instance as a unit. The keyword `this` is essentially a pointer to this instance, and in our example may be thought of as a variable of type `BigInt*`. Thus, the declaration `DigitStream a(*this)` creates an instance of `DigitStream` for the left operand of `operator+()`.

## The Member Function `BigInt::print()`

The implementation of the member function `print()` is straightforward:

```
void BigInt::print ()
{
    int i;
    for (i = ndigits-1; i >= 0; i--) printf("%d",digits[i]);
}
```

It loops through the `digits` array from the most significant through the least significant digits, calling the standard C library function `printf()` to print each digit.

## The `BigInt` Destructor

The only thing that the `BigInt` destructor function `~BigInt()` must do is free the dynamic storage allocated by the constructors:

```
BigInt::~BigInt ()
{
    delete digits;
}
```

This is done using the C++ `delete` operator, which in this case frees the dynamic storage that is pointed to by `digits`. The `delete` operator does what is usually accomplished in C by calling the standard C library function `free`, but in addition, if we use `delete` to deallocate an instance of a class having a destructor function, the destructor is called automatically to finalize the instance just before its storage is freed. The `delete` operator is thus the inverse of the `new` operator.

## Inline Functions

By now you may be thinking that the overhead of calling all of these little member functions must make C++ inefficient. This would be unacceptable for a proper successor to C, which is renowned for its efficiency! So C++ allows us to declare a function to be **inline**, in which case each call of the function is replaced by a copy of the entire function, much like the substitution performed for the **#define** preprocessor command. This entirely eliminates the overhead of calling a function, and makes encapsulation practical.

To make a function such as `~BigInt()` inline, we must move its implementation from the file `BigInt.c` to the file `BigInt.h` and add the keyword **inline** to the function definition:

```
inline BigInt::~~BigInt ()
{
    delete digits;
}
```

The function definition must be in `BigInt.h` because it will be needed by the compiler whenever a client program uses a `BigInt`.

Small functions make the best candidates for inline compilation. C++ gives us a convenient shorthand for writing **inline** functions: we can include the function body in the function declaration within the class declaration. Thus, we can also make `~BigInt()` inline by writing:

```
~BigInt () { delete digits; }
```

in the declaration of class `BigInt`.

Here is a complete version of `BigInt.h` showing appropriate functions made inline:

```
#include <stdio.h>

class BigInt {
    char* digits;           // pointer to digit array in free store
    int ndigits;           // number of digits
    BigInt(char* d, int n) { // constructor function
        digits = d;
        ndigits = n;
    }
    friend DigitStream;
public:
    BigInt(const char*);   // constructor function
    BigInt(int);           // constructor function
    BigInt(const BigInt&); // initialization constructor function
    BigInt operator+(const BigInt&); // addition operator function
    void print();         // printing function
    ~BigInt() { delete digits; } // destructor function
};

class DigitStream {
    char* dp;           // pointer to current digit
    int nd;             // number of digits remaining
};
```

```
public:
    DigitStream(const BigInt& n) { // constructor function
        dp = n.digits;
        nd = n.ndigits;
    }
    int operator++() { // return current digit and advance
        if (nd == 0) return 0;
        else {
            nd--;
            return *dp++;
        }
    }
};
```

## Summary

This completes our example abstract data type **BigInt**. Let's review the C++ features presented in this section:

- the *scope resolution operator*, which allows us to specify which class we mean when one or more classes have member variables or functions with the same name;
- *constant types*, which we can use to protect variables or function arguments from unintended modification;
- *implicit member variable references* and the keyword **this**, which are used within member functions to access the instance for which the function is called;
- the **new** and **delete** operators, which manage the free storage area and call class constructors/destructors if present;
- *references*, which we can use to conveniently pass pointers to instances instead of the instances themselves as function arguments;
- *friend functions*, which give us a way to grant access to the private member variables and functions of a class to other functions and classes; and,
- *inline functions*, which make data abstraction in C++ efficient and practical.

---

## Other Uses for Abstract Data Types

Our `BigInt` abstract data type is an obvious application for the technique of data abstraction because it is a numeric data type, like `int`, and it is natural to extend the meanings of C++'s arithmetic operators to apply to `BigInts`. As you become more familiar with this technique, you'll discover many opportunities for using abstract data types in your programs. Here are a few examples:

### Dynamic Character Strings

We can define a dynamic (i.e., variable length) character string abstract data type that works like the string variables in languages such as BASIC. We can overload the operators `&` and `&=` to concatenate character strings, overload the relational operators `<`, `<=`, `==`, and so on to compare character strings, and overload the array subscript operator `[ ]` to address the individual characters of a string. The function call operator:

```
operator() (int position, int length)
```

can be overloaded to perform substring extraction and replacement.

### Complex Numbers

C++, like C, doesn't have a built-in complex data type, but it's easy to define one in C++. In fact, one is distributed with the C++ compiler. Class `complex` has two member variables of type `double` that hold the real and imaginary parts of a complex number, and all of the usual arithmetic operators are overloaded to perform complex arithmetic when applied to instances of class `complex`. Many of the functions in the math library, such as `cos()` and `sqrt()`, are overloaded for complex arguments.

### Vectors

Vectors are another useful abstract data type. We can define classes for vectors of the fundamental data types, such as `FloatVec`, `DoubleVec`, and `IntVec`, and overload the arithmetic operators to apply element-by-element to vectors. The array subscript operator `[ ]` can be overloaded to check the range of vector subscripts or to handle vectors with arbitrary subscript bounds. It's also possible to overload the function call operator `()` to subscript multi-dimensional arrays.

### Stream I/O

A stream I/O package is distributed with the C++ compiler that defines the class `iostream` (input/output stream) for doing formatted I/O. This class defines an instance named `cin` connected to the standard input file and overloads the operator `>>` for all the fundamental data types so we can write:



```
float x;  
int i;  
char* s;  
cin >> x >> i >> s;
```

to read a `float`, and `int`, and a character string from the standard input file, for example. The advantage of this over using the C library function `scanf()` is that it is not possible to make the following types of errors:

```
int i;  
scanf("%f",&i); // float format for int  
scanf("%d",i); // int instead of int*
```

Similarly, class `ostream` defines an instance named `cout` connected to the standard output file and an instance named `cerr` connected to the standard error file. It overloads the operator `<<` for all the fundamental data types so we can write:

```
cout << x << i << s;
```

to write a `float`, and `int`, and a character string to the standard output file.

We can also add our own overloads for the operators `>>` and `<<` for classes we've written so we can read or write instances of these classes using the same notation.

---

# Object-Oriented Programming in C++

Perhaps the most interesting features of C++ are those that support the style of programming known as *object-oriented programming*. Object-oriented programming is generally useful, but is particularly suited for interactive graphics, simulation, and systems programming applications.

## Derived Classes

Suppose we have written a C++ class defining an abstract data type, and we need another abstract data type that is similar to it. Perhaps it requires some additional member variables or functions, or a few of its member functions must do something differently. We'd like to reuse the code we've already written and debugged as much as possible. C++ gives us a simple way to accomplish this: we can declare the new class as a *derived class* of our existing class, called the *base class*. The derived class *inherits* all of the member variables and functions of its base class. We can then differentiate the derived class from its base class by adding member variables, adding member functions, or re-defining member functions inherited from the base class.

A base class may have more than one derived class, and a derived class may, in turn, serve as the base class for other derived classes. Thus, we can define an entire tree-structured arrangement of related classes. This gives us a coherent way to organize classes and to share common code among them.

## Virtual Functions

Now suppose we're writing a graphics package, and we've written some classes for various geometric shapes, such as **Line**, **Triangle**, **Rectangle**, and **Circle**. All of these classes implement some of the same member functions, for example **draw()** and **move()**. The relevant class declarations for class **Line** and class **Circle** would look like this:

```
class Line {
    int x1,y1,x2,y2;           // end point coordinates
public:
    Line(int xx1,int yy1,int xx2,int yy2) // constructor
        { x1=xx1; y1=yy1; x2=xx2; y2=yy2; }
    void draw();              // draw a line from (x1,y1) to (x2,y2)
    void move(int dx, int dy); // move line by amount dx,dy
};

class Circle {
    int x,y;                  // center of circle
    int r;                    // radius of circle
public:
    Circle(int xx,int yy,int rr) // constructor
        { x=xx; y=yy; r=rr; }
    void draw();              // draw circle with center (x,y) and radius
    void move(int dx, int dy); // move circle by amount dx,dy
};
```

There are a couple of things we'd like to be able to do with these related classes. First, it would be useful to have an abstract data type called **Picture** that would be a collection of **Lines**, **Triangles**, **Rectangles**, and **Circles**. Second, we'd like to be able to **draw()** and **move()** our **Pictures**.

It would be most elegant if class **Picture** were general, and contained no mention of the specific shapes. That way, we could introduce a new shape, say a **Pentagon**, and not have to change class **Picture** in any way.

We can do this by defining a base class **Shape** with derived classes **Line**, **Triangle**, and so on, as shown in Figure 2-6.

Figure 2-6: Organization of Classes for a Graphics Package

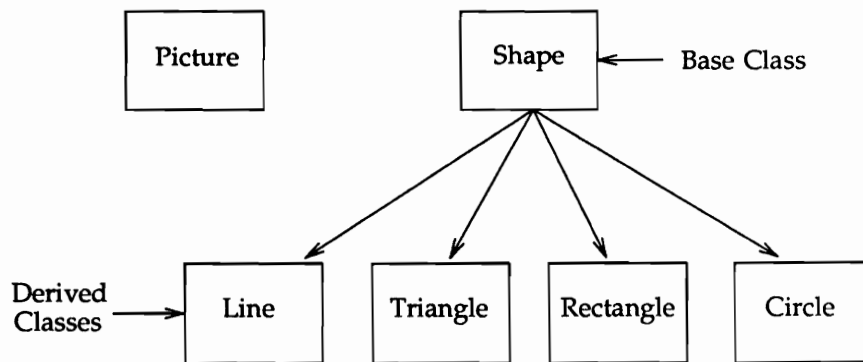

Class **Shape** declares functions applicable to any kind of shape such as **draw()** and **move()** as **virtual** functions, and implements these functions to write out an error message if called:

```

class Shape {
public:
    virtual void draw();           // Shape::draw() prints error message
    virtual void move(int dx, int dy); // Shape::move() prints error message
};

```

We change the declarations of classes **Line**, **Triangle**, and so on to be derived from class **Shape** by adding the name of the base class to the declaration of the derived class; for example:

```

class Line : public Shape { ...
class Circle : public Shape { ...

```

and we also add the keyword **virtual** to the declarations of the functions **draw()** and **move()** in the derived classes. We don't have to change the implementation of these functions, however.

Now we can write class **Picture** to deal only with **Shapes**. We can represent a **Picture** by an array containing pointers to its component **Shapes**, and we can implement **Picture::draw()**, for example, simply by calling **Shape::draw()** for each shape in the picture:

```
const int PICTURE_CAPACITY = 100;           // max number of shapes in picture
class Picture {
    Shape* s[PICTURE_CAPACITY];           // array of pointers to shapes
    int n;                                 // current number of shapes in picture
public:
    Picture() { n = 0; }                   // constructor
    void add(const Shape&);                 // add shape to picture
    void draw();                           // draw picture
    void move(int dx, int dy);             // move picture
};

void Picture::add(const Shape& t)           // add a shape to a picture
{
    if (n == PICTURE_CAPACITY) {
        cerr << "Picture capacity exceeded\n";
        exit(1);
    }
    s[n++] = &t;                           // add pointer to shape to picture
}

void Picture::draw()                       // draw a picture
{
    int i;
    for (i=0; i<n; i++) s[i]->draw();
}
```

Since `Shape::draw()` is a **virtual** function, C++ takes care of figuring out the specific class of each component `Shape` when the program is executed and calling the appropriate implementation of `draw()` for that class. This is called *dynamic binding*.

If we mistakenly forget to implement `draw()` for a derived class of `Shape`, it will inherit the implementation of `draw()` from class `Shape`. When we try to draw that shape, `Shape::draw()` will be executed, which issues an error message, as you'll recall.

Going a step further, we might want to be able to build a more complicated picture out of a number of simpler pictures. We can do this by thinking of a `Picture` as just another type of `Shape`, and making it another derived class of class `Shape`, leading to the class structure shown in Figure 2-7.

Figure 2-7: Improved Organization of Classes for a Graphics Package

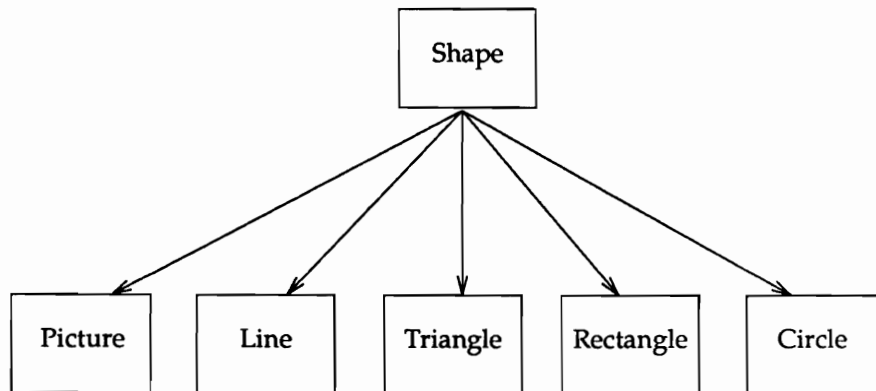

## Class Libraries

Taking this technique to its extreme, we can define a class named, say, **Object** and derive *every* class from it, either directly or indirectly. In class **Object** we can declare virtual functions that apply to all classes — functions for copying, printing, storing, reading, and comparing objects, for example. We then can define general data structures comprised of **Objects** and functions that operate on them that will be useful for all classes, just as class **Picture** could work with any derived class of **Shape**.

The author has written a library of about 40 general-purpose classes, modeled after the basic classes of the Smalltalk-80 programming language. The library, known as the Object-Oriented Program Support (OOPS) class library, contains classes such as **String**, **Date**, **Time**, **Set** (hash tables), **Dictionary** (associative arrays), and **LinkedList**.

Writing C++ programs using a class library such as this is a real delight. The classes are general-purpose, and most programs of any size will have uses for some of them. They are flexible — if a particular class doesn't quite do what is needed it's usually a simple matter to derive a class that does. And the library is extensible. It provides a framework that makes it easy to add your own custom classes and make them function along with existing ones.

As an example, let's see how the OOPS class library can help us with the graphics package we've been discussing. The OOPS library has a class **Point** for representing x-y coordinates. We can use it in graphics classes such as **Line**:

```

class Line : public Shape {
    Point a,b;                // endpoints of the line
public:
    Line(Point p1, Point p2) { a=p1; b=p2; } // constructor
    void draw();              // draw a line from point a to point b
    void move(Point delta);   // move line by delta
};

```

Many of the arithmetic operators are defined by class `Point`, so we can implement `move()`, for example, by writing:

```

void Line::move(Point delta)
{
    a += delta; b += delta;
}

```

Our crude implementation of class `Picture` allocated an array of fixed size to hold the pointers to its component shapes. We can use the OOPS library class `OrderedCltn` to make this a variable-length array. An `OrderedCltn` is an array of pointers to `Objects`, so we can use it to hold pointers to instances of any class derived from `Object`, just as we used an array of pointers to `Shapes` to hold pointers to `Lines`, `Triangles`, and so on. To make class `Shape` a derived class of `Object`, we modify its declaration:

```

class Shape : public Object { ...

```

Now we can write class `Picture` as:

```

class Picture : public Shape {
    OrderedCltn s;                // collection of pointers to shapes
public:
    Picture() {}                 // constructor
    virtual void add(const Shape&); // add shape to picture
    virtual void draw();         // draw picture
    virtual void move(Point delta); // move picture
};

```

Class `OrderedCltn` defines member functions such as `add()`, `remove()`, `size()`, `first()`, and `last()` to let us manipulate the pointers in the array. It also overloads the subscript operator `[ ]` so we can subscript `OrderedCltns` like arrays. Using these we can write the functions `Picture::add()` and `Picture::draw` as follows:

```

void Picture::add(const Shape& t)           // add a shape to a picture
{
    s.add(t);                             // this calls OrderedCltn::add()
}

void Picture::draw()                      // draw a picture
{
    int i;
    for (i=0; i<s.size(); i++)           // s.size() returns # of objects in s
        ((Shape*)s[i])->draw();         // cast address of ith
                                        // to Shape* and call draw()
}

```

Now **Pictures** can have as many shapes in them as we need; class **OrderedCltn** manages the required storage for us.

## Object I/O

Let's write a program that uses our graphics classes to create a simple picture composed of two shapes — a line and a circle:

```

main()
{
    Picture pict;
    pict.add(*new Line(Point(0,0),Point(10,10)));
    pict.add(*new Circle(Point(10,10),2));
    pict.draw();
}

```

The first statement in the body of **main()** declares an instance of class **Picture** named **pict**, the second statement constructs an instance of **Line** with endpoints at (0,0) and (10,10) and adds it to **pict**, and the third statement constructs an instance of **Circle** with the center at (10,10) and radius 2 and also adds it to **pict**. The result is the data structure shown in Figure 2-8.

Figure 2-8: The data structure of a simple picture. Instances of OOPS library classes are shown as dashed rectangles.

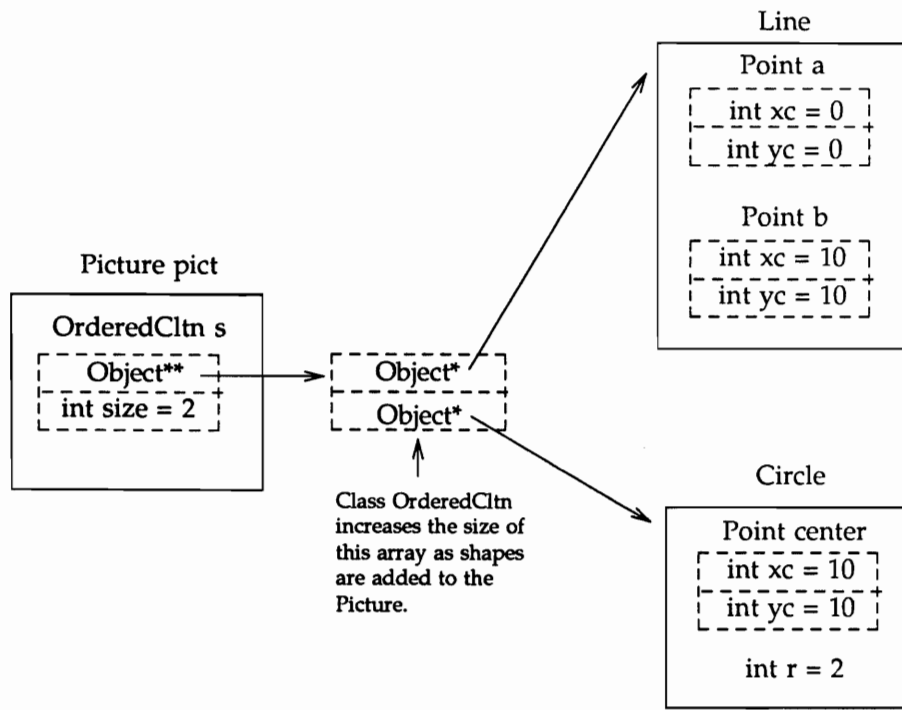

What if we wanted to save this data structure on a disk file so it could be read in later and used by another program? The OOPS class library makes this simple. We create an output stream (an instance of class `fstream`) named, for example, `out`, and write the picture to it with the statements:

```

#include <iostream.h>           // include header files for
#include <fstream.h>           // standard C++ stream I/O
// ...
fstream out ("picturefile",output); // create "picturefile"
pict.storeOn(out);

```

The function `storeOn()`, which is implemented in class `Object`, handles the details of finding all of the objects in the picture data structure and writing them to the output stream in a program-independent, machine-independent format. The `storeOn()` function calls the virtual function `storer()` to actually write out member variables. The `storer()` function is declared in class `Object`, and is reimplemented by each derived class to write out its own member variables. This function is already implemented for all of the OOPS library classes, but we must write one for any classes of our own which we've derived from class `Object`. That's easy to do. For example, the `storer()` function for class `Picture` looks like:



```
void Picture::storer(iostream& strm)
{
    Shape::storer(strm);    // store members of base class, if any
    s.storeOn(strm);       // store member of class Picture
}
```

To read a picture from a file, we create an input stream, `in`, (an instance of class `fstream`) connected to the file we wish to read, and read the picture from it with the statements:

```
#include <iostream.h>           // include header files for
#include <fstream.h>           // standard C++ stream I/O
// ...
fstream in("picturefile",input); // open "picturefile" read-only
readFrom(in,"Picture",pict);
```

The second argument tells `readFrom()` that we're expecting an instance of class `Picture` to be read, and to complain if the next object on the input stream is of any other class.

The function `readFrom()` works somewhat like `storeOn()`, calling a small "reader" function which we must write for each of our classes.

We can use OOPS object I/O to store and read an arbitrarily complex data structure containing instances of both OOPS library classes and our own classes. Since the data structure is converted into a program-independent, machine-independent format, we can send it through a UNIX pipe to another process running on the same machine, or over a network to another process running on a different kind of machine. This capability is particularly useful for spread sheets, forms, documents, drawings, electronic mail, and so on. The OOPS class library also gives us a framework to use when implementing object I/O for our own classes. We don't have to spend time designing a storage format, or worry about such issues as what to do with the pointers in a data structure, for example. We can use the general-purpose mechanism provided by the OOPS class library, and concentrate on our particular application.

---

## The Current Status of C++

The C++ programming language is currently implemented as a *translator*, which accepts C++ source code as input and produces C source code as output. The C++ translator and run-time support library are written in C++, making them easily portable to most UNIX systems.

AT&T first made the C++ translator available to universities and non-profit organizations in December, 1984. Release 1.0 became commercially available as an unsupported product in October, 1985.

The AT&T C++ Language System can run on any UNIX machine capable of running programs up to about 500KB in size, and having a robust C compilation system that can handle variable and external symbol names of arbitrary length. The C compiler must also allow structure assignments and the use of structures as function arguments and return values.

Training and third-party supported ports of the AT&T C++ Translator can be obtained for various UNIX systems, VAX VMS, MS-DOS, and others.

---

## The Future of C++

The definition of the C++ programming language is not yet final. When the ANSI C standard is completed, C++ will undoubtedly be revised to eliminate any unnecessary incompatibilities; for example, the ANSI C rules for doing floating point arithmetic will be adopted. Historically, C++ has met the challenge of evolving while remaining compatible with C and earlier versions of C++.

Will the C++ programming language be as successful as its predecessor, or will it become just another of the countless languages that never achieve widespread use? Well, C++ has a lot going for it:

- Since C++ is, with a few minor exceptions, a superset of C, it has no fatal deficiencies. It also possesses those attributes of C that have contributed to C's success: portability, flexibility, and efficiency.
- C++ is less error-prone than C. It thoroughly type-checks programs, as is the trend in modern programming languages, but not at the expense of flexibility or convenience. A programmer may coerce (cast) types when necessary, and define his or her own implicit type conversions for convenience.
- Support for data abstraction and object-oriented programming make C++ a much more powerful and expressive language than C. Yet the language remains one of manageable size, much smaller than PL/1 or ADA, for example.
- C++ programs are compatible with UNIX and with the large number of existing C libraries for graphics, database management, math, and statistics.
- There is a large existing community of C programmers who can begin to use C++ immediately, gradually learning and utilizing its new features.
- The AT&T C++ Language System is commercially available in source form, is inexpensive, and is highly portable. It makes the language accessible on almost all popular operating systems.
- AT&T is developing a portable C++ compiler, which will compile C++ programs more quickly than the combination of the C++ Translator and C compiler now required.
- C++ was designed at the AT&T Bell Laboratories Computer Science Research Center in Murray Hill. They have an impressive track record in producing successful software, such as the UNIX system and C language.

The main obstacle to the widespread adoption of C++ is that to realize its benefits one must master the techniques of data abstraction and/or object-oriented programming — techniques that are unfamiliar to the current generation of programmers. When this educational problem is solved, C++ should succeed C as the language of choice for a wide range of applications.

---

## Footnotes

1. This paper fits the description in the U.S. Copyright Act of a "United States Government work." It was written as a part of the author's official duties as a Government employee. This means it cannot be copyrighted. This paper is freely available to the public for use without a copyright notice, and there are no restrictions on its use, now or subsequently.

The author's time and the computer facilities required to prepare this paper were provided by the Computer Systems Laboratory, Division of Computer Research and Technology, National Institutes of Health.

2. Binary operators such as `+` are usually not defined as member functions because automatic conversion of types is not done for the left operand. For example, the expression `a + 47` is equivalent to `a.operator+(47)`. C++ recognizes that the function `operator+(const BigInt&)` is defined and that the constructor `BigInt(int)` can be used to convert the `int 47` to a `BigInt` before calling `operator+`. However, the expression `47 + a` is equivalent to `47.operator+(a)`, which is an error because `47` is not an instance of a class and therefore has no member functions that can be applied to it. For this reason, binary operators are usually defined as *friend* functions, which are discussed later.

---

# 3 An Overview of C++

---

<b>An Overview of C++</b>	3-1
Introduction	3-1
What is Good about C?	3-1
A Better C	3-2
■ Argument Type Checking and Coercion	3-2
■ Inline Functions	3-3
■ Scoped and Typed Constants	3-3
■ Varying Numbers of Arguments	3-3
■ Declarations as Statements	3-4
Support for Data Abstraction	3-5
■ Initialization and Cleanup	3-6
■ Free Store Operators	3-6
■ References	3-7
■ Assignment and Initialization	3-8
■ Operator Overloading	3-9
■ Coercions	3-9
Support for Object-Oriented Programming	3-10
■ Derived Classes	3-10
■ Virtual Functions	3-12
■ Visibility Control	3-13
What is Missing?	3-14
Conclusions	3-15

---

<b>Footnotes</b>	3-16
------------------	------



---

# An Overview of C++

NOTE

This chapter is taken directly from a paper by Bjarne Stroustrup.

## Introduction

C++ is a general purpose programming language designed to make programming more enjoyable for the serious programmer. Except for minor details, C++ is a superset of the C language. C++ was designed to

- be a better C
- support data abstraction
- support object-oriented programming

This paper describes the features added to C to achieve this. In addition to C, the main influences on the design of C++ were Simula67 and Algol68.

C++ has been in use for about four years and has been applied to most branches of systems programming including compiler construction, data base management, graphics, image processing, music synthesis, networking, numerical software, programming environments, robotics, simulation, and switching. It has a highly portable implementation and there are now thousands of installations including AT&T 3B, DEC VAX, Intel 80286, Motorola 68000, and Amdahl machines running UNIX and other operating systems.

## What is Good about C?

C is clearly not the cleanest language ever designed nor the easiest to use; so why do so many people use it?

- C is flexible: it is possible to apply C to most every application area, and to use most every programming technique with C. The language has no inherent limitations that preclude particular kinds of programs being written.
- C is efficient: the semantics of C are "low level"; that is, the fundamental concepts of C mirror the fundamental concepts of a traditional computer. Consequently, it is relatively easy for a compiler and/or a programmer to utilize hardware resources for a C program efficiently.
- C is available: given a computer, whether the tiniest micro or the largest super-computer, the chance is that there is an acceptable quality C compiler available and that that C compiler supports an acceptably complete and standard C language and library. There are also libraries and support tools available, so that a programmer rarely needs to design a new system from scratch.
- C is portable: a C program is not automatically portable from one machine (and operating system) to another nor is such a port necessarily easy to do. It is, however, usually possible and the level of difficulty is such that porting even major pieces of software with inherent machine dependences is typically technically and economically feasible.

Compared with these "first order" advantages, the "second order" drawbacks like the curious C declarator syntax and the lack of safety of some language constructs become less important. Designing "a better C" implies compensating for the major problems involved in writing, debugging, and maintaining C programs *without compromising the advantages of C*. C++ preserves all these advantages and compatibility with C at the cost of abandoning claims to perfection and of some compiler and language complexity. However, designing a language "from scratch" does not ensure perfection and the C++ compilers compare favorably in run-time, have better error detection and reporting, and equal the C compilers in code quality.

## A Better C

The first aim of C++ is to be "a better C" by providing better support for the styles of programming for which C is most commonly used. This primarily involves providing features that make the most common errors unlikely (since C++ is a superset of C such errors cannot simply be made impossible).

### Argument Type Checking and Coercion

The most common error in C programs is a mismatch between the type of a function argument and the type of the argument expected by the called function. For example:

```
double sqrt(a) double a;
{
    /* ... */
}

double sq2 = sqrt(2);
```

Since C does not check the type of the argument 2, the call `sqrt(2)` will typically cause a run time error or give a wrong result when the square root function tries to use the integer 2 as a double precision floating point number. In C++, this program will cause no problem since 2 will be converted to a floating point number at the point of the call. That is, `sqrt(2)` is equivalent to `sqrt((double)2)`.

Where an argument type does not match the argument type specified in the function declaration and no type conversion is defined the compiler issues an error message. For example, in C++ `sqrt("Hello")` causes a compile time error.

Naturally, the C++ syntax also allows the type of arguments to be specified in function declarations:

```
double sqrt(double);
```

and a matching function definition syntax is also introduced:

```
double sqrt(double d)
{
    // ...
}
```



## Inline Functions

Most C programs rely on macros to avoid function call overhead for small frequently-called operations. Unfortunately the semantics of macros are very different from the semantics of functions so the use of macros has many pitfalls. For example:

```
#define mul(a,b) a*b
int z = mul(x*3+2,y/4);
```

Here `z` will be wrong since the macro will expand to `x*3+2*y/4`. Furthermore, C macro definitions do not follow the syntactic rules of C declarations, nor do macro names follow the usual C scope rules. C++ circumvents such problems by allowing the programmer to declare inline functions:

```
inline int mul(int a, int b) { return a*b; }
```

An inline function has the same semantics as a “normal” function but the compiler can typically inline expand it so that the code-space and run-time efficiency of macros are achieved.

## Scoped and Typed Constants

Since C does not have a concept of a symbolic constant macros are used. For example:

```
#define TBLMAX (TBLSIZE-1)
```

Such “constant macros” are neither scoped nor typed and can (if not properly parenthesized) cause problems similar to those of other macros. Furthermore, they must be evaluated each time they are used and their names are “lost” in the macro expansion phase of the compilation and consequently are not known to symbolic debuggers and other tools. In C++ constants of any type can be declared:

```
const int TBLMAX = TBLSIZE-1;
```

## Varying Numbers of Arguments

Functions taking varying numbers of arguments and functions accepting arguments of different types are common in C. They are a notable source of both convenience and errors.

C functions where the type of arguments or the number of arguments (but not both) can vary can be handled in a simple and type-secure manner in C++. For example, a function taking one, two, or three arguments of known type can be handled by supplying default argument values which the compiler uses when the programmer leaves out arguments. For example:

```
void print(char*, char* = "-", char* = "-");

print("one", "two", "three");
print("one", "two"); // that is, print("one", "two", "-");
print("one"); // that is, print("one", "-", "-");
```

Some C functions take arguments of varying types to provide a common name for functions performing similar operations on objects of different types. This can be handled in C++ by overloading a function name. That is, the same name can be used for two functions provided the argument types are sufficiently different to enable the compiler to “pick the right one” for each call. For example:

```
void print(int);
void print(char*);

print(1);      // integer print function
print("two"); // string print function
```

The most general examples of C functions with varying arguments cannot be handled in a type-secure manner. Consider the standard output function `printf`, which takes a format string followed by an arbitrary collection of arguments supposedly matching the format string:<sup>1</sup>

```
printf("a string");
printf("x = %d\n", x);
printf("name: %s\n size: %d\n", obj.name, obj.size);
```

However, in C++ one can specify the type of initial arguments and leave the number and type of the remaining arguments unspecified. For example, `printf` and its variants can be declared like this:

```
int printf(const char* ...);
int fprintf(FILE*, const char* ...);
int sprintf(char*, const char* ...);
```

These declarations allow the compiler to catch errors such as

```
printf(stderr, "x = %d\n", x); // error: printf does not take a FILE*
fprintf("x = %d\n", x);       // error: fprintf needs a FILE*
```

### Declarations as Statements

Uninitialized variables are another common source of errors. One cause of this class of errors is the requirement of the C syntax that declarations can occur only at the beginning of a block (before the first statement). In C++, a declaration is considered a kind of statement and can consequently be placed anywhere. It is often convenient to place the declaration where it is first needed so that it can be initialized immediately. For example:

```
void some_function(char* p)
{
    if (p==0) error("p==0 in some_function");
    int length = strlen(p);
    // ...
}
```

## Support for Data Abstraction

C++ provides support for data abstraction: the programmer can define types that can be used as conveniently as built-in types and in a similar manner. Arithmetic types such as rational and complex numbers are common examples:

```
class complex {
    double re, im;
public:
    complex(double r, double i) { re=r; im=i; }
    complex(double r) { re=r; im=0; } // float->complex conversion

    friend complex operator+(complex, complex);
    friend complex operator-(complex, complex); // binary minus
    friend complex operator-(complex); // unary minus
    friend complex operator*(complex, complex);
    friend complex operator/(complex, complex);
    // ...
}
```

The declaration of class (that is, user-defined type) `complex` specifies the representation of a complex number and the set of operations on a complex number. The representation is *private*; that is, `re` and `im` are accessible only to the functions defined in the declaration of class `complex`. Such functions can be defined like this:

```
complex operator+(complex a1, complex a2)
{
    return complex(a1.re+a2.re, a1.im+a2.im);
}
```

and used like this:

```
main()
{
    complex a = 2.3;
    complex b = 1/a;
    complex c = a+b+complex(1,2.3);
    // ...
}
```

Functions declared in a class declaration using the keyword `friend` are called *friend functions*. They do not differ from ordinary functions except that they may use private members of classes that name them friends. A function can be declared as a friend of more than one class. Other functions declared in a class declaration are called *member functions*. A member function is in the scope of the class and must be invoked for a specific object of that class.

## Initialization and Cleanup

When the representation of a type is hidden some mechanism must be provided for a user to initialize variables of that type. A simple solution is to require a user to call some function to initialize a variable before using it. This is error prone and inelegant. A better solution is to allow the designer of a type to provide a distinguished function to do the initialization. Given such a function, allocation and initialization of a variable becomes a single operation (often called instantiation) instead of two separate operations. Such an initialization function is called a constructor. In cases where construction of objects of a type is non-trivial one often needs a complementary operation to clean up objects after their last use. In C++ such a cleanup function is called a destructor. Consider a vector type:

```
class vector {
    int sz;           // number of elements
    int* v;          // pointer to integers
public:
    vector(int);     // constructor
    ~vector();      // destructor
    // ...
};
```

The vector constructor can be defined to allocate a suitable amount of space like this:

```
vector::vector(int s)
{
    if (s<=0) error("bad vector size");
    sz = s;
    v = new int[s]; // allocate an array of "s" integers
}
```

The cleanup done by the vector destructor consists of freeing the storage used to store the vector elements for re-use by the free store manager:

```
vector::~~vector()
{
    delete v; // deallocate the memory pointed to by v
}
```

C++ does not support garbage collection. This is, however, compensated for by enabling a type to maintain its own storage management without requiring intervention from a user. Class vector is an example of this.

## Free Store Operators

The operators `new` and `delete` were introduced to provide a standard notation for free store allocation and deallocation. A user can provide alternatives to their default implementations by defining functions called `operator new` and `operator delete`. For built-in types the `new` and `delete` operators provide only a notational convenience (compared with the standard C functions `malloc()` and `free()`). For user-defined types such as `vector` the free store operators ensure that constructors and destructors are called properly:

```

vector* fct1(int n)
{
    vector v(n);           // allocate a vector on the stack
                          // the constructor is called
    vector* p = new vector(n); // allocate a vector on the free store
                          // the constructor is called
    // ...
    return p;
    // the destructor is implicitly called for "v" here
}

void fct2()
{
    vector* pv = fct1(10);
    // ...
    delete pv; // call the destructor and free the store
}

```

## References

C provides (only) "call by value" semantics for function argument passing; "call by reference" can be simulated by explicit use of pointers. This is sufficient, and often preferable to using "pass by value" for the built-in types of C. However, it can be inconvenient for larger objects<sup>2</sup> and can get seriously in the way of defining conventional notation for user-defined types in C++. Consequently, the concept of a *reference* is introduced. A reference acts as a name for an object; T& means reference to T. A reference must be initialized and becomes an alternative name for the object it is initialized with. For example:

```

int a = 1; // "a" is an integer initialized to "1"
int& r = a; // "r" is a reference initialized to "a"

```

The reference r and the integer a can now be used in the same way and with the same meaning. For example:

```

int b = r; // "b" is initialized to the value of "r", that is, "1"
r = 2; // the value of "r", that is, the value of "a" becomes "2"

```

References enable variables of types with "large representations" to be manipulated efficiently without explicit use of pointers. Constant references are particularly useful:

```

matrix operator+(const matrix& a, const matrix& b)
{
    // code here cannot modify the value of "a" or "b"
}

matrix a = b+c;

```

In such cases the "call by value" semantics are preserved while achieving the efficiency of "call by reference."

## Assignment and Initialization

Controlling construction and destruction of objects is sufficient for many, but not all, types. It can also be necessary to control all copy operations. Consider:

```
vector v1(100);      // make v1 a vector of 100 elements
vector v2 = v1;     // make v2 a copy of v1
v1 = v2;            // assign v1 to v2 (that is, copy the elements)
```

Declaring a function with the name `operator=` in the declaration of class `vector` specifies that vector assignment is to be implemented by that function:

```
class vector {
    int* v;
    int sz;
public:
    // ...
    void operator=(vector&); // assignment
};
```

Assignment might be defined like this:

```
void vector::operator=(vector& a) // check size and copy elements
{
    if (sz != a.sz) error("bad vector size for =");
    for (int i = 0; i < sz; i++) v[i] = a.v[i];
}
```

Since the assignment operation relies on the "old value" of the vector assigned to, it cannot be used to implement initialization of one vector with another. What is needed is a constructor that takes a vector argument:

```
class vector {
    // ...
    vector(int);      // create vector
    vector(vector&);  // create vector and copy elements
};

vector::vector(vector& a) // initialize a vector from another vector
{
    sz = a.sz;          // same size
    v = new int[sz];    // allocate element array
    for (int i = 0; i < sz; i++) v[i] = a.v[i]; // same values
}
```

A constructor like this (of the form `X(X&)`) is used to handle all initialization. This includes arguments passed "by value" and function return values:

```

vector v2 = v1; // use vector(vector&) constructor to initialize

void f(vector);
f(v2);          // use vector(vector&) constructor to pass a copy of v2

vector g(int sz)
{
    vector v(sz);
    return v;   // use vector(vector&) constructor to return a copy of v
}

```

## Operator Overloading

As demonstrated above, standard operators like `+`, `-`, `*`, `/` can be defined for user-defined types, as can assignment and initialization in its various guises. In general, all the standard operators with the exception of

?:

can be overloaded. The subscripting operator `[]` and the function application operator `()` have proven particularly useful. The C "operator assignment" operators, such as `+=` and `*=`, have also found many uses.

It is not possible to redefine an operator when applied to built-in data types, to define new operators, or to redefine the precedence of operators.

## Coercions

User-defined coercions, like the one from floating point numbers to complex numbers implied by the constructor `complex(double)`, have proven unexpectedly useful in C++. Such coercions can be applied explicitly or the programmer can rely on the compiler adding them implicitly where necessary and unambiguous:

```

complex a = complex(1);
complex b = 1;          // implicit: 1 -> complex(1)
a = b+complex(2);
a = b+2;                // implicit: 2 -> complex(2)
a = 2+b;                // implicit: 2 -> complex(2)

```

Coercions were introduced into C++ because mixed mode arithmetic is the norm in languages used for numerical work and because most user-defined types used for "calculation" (for example, matrices, character strings, and machine addresses) have natural mappings to and/or from other types.

Great care is taken (by the compiler) to apply user-defined conversions only where a unique conversion exists. Ambiguities caused by conversions are compile time errors.

It is also possible to define a conversion to a type without modifying the declaration of that type. For example:

```
class point {
    float dist;
    float angle;
public:
    // ...
    operator complex() // convert point to complex number
    {
        return polar(dist,angle);
    }
    operator double() // convert point to real number
    {
        if (angle) error("cannot convert point to real: angle!=0");
        return dist;
    }
};
```

These conversions could be used like this:

```
void some_function(point a)
{
    complex z = a; // z = a.operator complex()
    double d = a; // d = a.operator double()
    complex z3 = a+3; // z3 = a.operator complex() + complex(3);
    // ...
}
```

This is particularly useful for defining conversions to built-in types since there is no declaration for a built-in type for the programmer to modify. It is also essential for defining conversions to "standard" user-defined types where a change may have (unintentionally) wide ranging ramifications and where the average programmer has no access to the declaration.

## Support for Object-Oriented Programming

C++ provides support for object-oriented programming: the programmer can define class hierarchies and a call of a member function can depend on the actual type of an object (even where the actual type is unknown at compile time). That is, the mechanism that handles member function calls handles the case where it is known at compile time that an object belongs to *some* class in a hierarchy, but exactly *which* class can only be determined at run time. See examples below.

### Derived Classes

C++ provides a mechanism for expressing commonality among different types by explicitly defining a class to be part of another. This allows re-use of classes without modification of existing classes and without replication of code. For example, given a class `vector`:



```

class vector {
    // ...
public:
    // ...
    vector(int);
    int& operator[] (int); // overload the subscripting operator: []
}

```

one might define a vector for which a user can define the index bounds:

```

class vec : public vector {
    int low, high;
public:
    vec(int, int);
    int& operator[] (int);
};

```

Defining `vec` as

```

: public vector

```

means that first of all a `vec` is a `vector`. That is, type `vec` has ("inherits") all the properties of type `vector` in addition to the ones declared specifically for it. Class `vector` is said to be the *base* class for `vec`, and conversely `vec` is said to be *derived* from `vector`.

Class `vec` modifies class `vector` by providing a different constructor, requiring the user to specify the two index bounds rather than the size, and by providing its own access function `operator[]()`. A `vec`'s `operator[]()` is easily expressed in terms of `vector`'s `operator[]()`:

```

int& vec::operator[] (int i)
{
    return vector::operator[] (i-low);
}

```

The scope resolution operator `::` is used to avoid getting caught in an infinite recursion by calling `vec::operator[]()` from itself. Note that `vec::operator[]()` *had* to use a function like `vector::operator[]()` to access elements. It could not just use `vector`'s members `v` and `sz` directly since they were declared *private* and therefore accessible only to `vector`'s member functions.

The constructor for `vec` can be written like this:

```

vec::vec(int lb, int hb) : vector(hb-lb+1)
{
    if (hb-lb<0) hb = lb;
    low = lb;
    high = hb;
}

```

The construct `:vector(hb-lb+1)` is used to specify the argument list needed for the base class constructor `vector()`.

Class `vec` can be used like this:

```
void some_function(int l, int h)
{
    vec v1(l,h);
    const int sz = h-l+1;
    vector v2(sz);
    // ...
    for (int i=0; i<sz; i++) v2[i] = v1[l+i]; // copy elements explicitly
    v2 = v1; // copy elements by using vector::operator=()
}
```

## Virtual Functions

Class derivation (often called subclassing) is a powerful tool in its own right but a facility for run-time type resolution is needed to support object-oriented programming.

Consider defining a type `shape` for use in a graphics system. The system has to support circles, triangles, squares, and many other shapes. First specify a class that defines the general properties of all shapes:

```
class shape {
    point center;
    color col;
    // ...
public:
    point where() { return center; }
    void move(point to) { center = to; draw(); }
    virtual void draw();
    virtual void rotate(int);
    // ...
};
```

The functions for which the calling interface can be defined, but where the implementation cannot be defined except for a specific shape, have been marked *virtual* (the Simula67 and C++ term for "to be defined later in a class derived from this one"). Given this definition one can write general functions manipulating shapes:

```
void rotate_all(shape* v, int size, int angle)
// rotate all members of vector "v" of size "size" "angle" degrees
{
    for (int i = 0; i < size; i++) v[i].rotate(angle);
}
```

For each shape `v[i]`, the proper `rotate` function for the actual type of the object will be called. That "actual type" is not known at compile time.

To define a particular shape we must say that it is a shape (that is, derive it from class `shape`) and specify its particular properties (including the virtual functions):

```

class circle : public shape {
    int radius;
public:
    void draw() { /* ... */ };
    void rotate(int) {} // yes, the null function
};

```

In many contexts it is important that the C++ virtual function mechanism is very nearly as efficient as a "normal" function call. The additional run-time overhead is about 4 memory references (dependent on the machine architecture and the compiler) and the memory overhead is one word per object plus one word per virtual function per class.

## Visibility Control

The basic scheme for separating the (public) user interface from the (private) implementation details has worked out very well for data abstraction uses of C++. It matches the idea that a type is a black box. It has proven to be less than ideal for object-oriented uses.

The problem is that a class defined to be part of a class hierarchy is not simply a black box. It is often primarily a building block for the design of other classes. In this case the simple binary choice *public/private* can be constraining. A third alternative is needed: a member should be private as far as functions outside the class hierarchy are concerned but accessible to member functions of a derived class in the same way that it is accessible to members of its own class. Such a member is said to be *protected*.

For example, consider a class `node` for some kind of tree:

```

class node {
    // private stuff
protected:
    node* left;
    node* right;
    // more protected stuff
public:
    virtual void print();
    // more public stuff
};

```

The pointers `left` and `right` are inaccessible to the general user but any member function of a class derived from class `node` can manipulate the tree without overhead or inconvenience.

The protection/hiding mechanism applies to names independently of whether a name refers to a function or a data member. This implies that one can have **private** and **protected** function members. Usually it is good policy to keep data **private** and present the **public** and **protected** interfaces as sets of functions. This policy minimizes the effect of changes to a class on its users and consequently maximizes its implementor's freedom to make changes.

Another refinement of the basic inheritance scheme is that it is possible to inherit public members of a base class in such a way that they do not become public members of the derived class. This can be used to provide restricted interfaces to standard classes. For example:

```
class dequeue {
    // ...
    void insert(elem*);
    void append(elem*);
    elem* remove();
};
```

Given a dequeue a stack can be defined as a derived class where only the insert() and remove() operations are defined:

```
class stack : private dequeue { // note: just ":" not ": public" members
                                // of dequeue are private members of stack
public:
    dequeue::insert;           // make "insert" a public member of stack
    dequeue::remove;          // make "remove" a public member of stack
};
```

Alternatively, inline functions can be defined to give these operations the conventional names:

```
class stack : private dequeue {
public:
    void push(elem* ee) { dequeue::insert(ee); }
    elem* pop() { return dequeue::remove(); }
};
```

## What is Missing?

C++ was designed under severe constraints of compatibility, internal consistency, and efficiency: no feature was included that

- would cause a serious incompatibility with C at the source or linker levels
- would cause run-time or space overheads for a program that did not use it
- would increase run-time or space requirements for a C program
- would significantly increase the compile time compared with C
- could only be implemented by making requirements of the programming environment (linker, loader, etc.) that could not be simply and efficiently implemented in a traditional C programming environment

Features that might have been provided but weren't because of these criteria include garbage collection, parameterized classes, exceptions, support for concurrency, and integration of the language with a programming environment. Not all of these possible extensions would actually be appropriate for C++ and unless great constraint is exercised when selecting and designing features for a language a large, unwieldy, and inefficient mess will result. The severe constraints on the design of C++ have probably been beneficial and will continue to guide the evolution of C++.

## Conclusions

C++ has succeeded in providing greatly improved support for traditional C-style programming without added overhead. In addition, C++ provides sufficient language support for data abstraction and object-oriented programming in demanding (both in terms of machine utilization and application complexity) real-life applications. C++ continues to evolve to meet demands of new application areas. There still appears to be ample scope for improvement even given the (self imposed) Draconian criteria for compatibility, consistency, and efficiency. However, currently the most active areas of development are not the language itself but libraries and support tools in the programming environment.

---

## Footnotes

1. A C++ I/O system that avoids the type insecurity of the `printf` approach is described in *The C++ Programming Language*.
2. As indicated by an inconsistency in the C semantics, arrays are always passed by reference.

---

# 4 Object-Oriented Programming

---

<b>What is "Object-Oriented Programming"?</b>	4-1
Abstract	4-1
Introduction	4-1
Programming Paradigms	4-2
■ Procedural Programming	4-2
■ Data Hiding	4-3
■ Data Abstraction	4-5
■ Problems with Data Abstraction	4-7
■ Object-Oriented Programming	4-8
Support for Data Abstraction	4-9
■ Initialization and Cleanup	4-9
■ Assignment and Initialization	4-10
■ Parameterized Types	4-12
■ Exception Handling	4-13
■ Coercions	4-14
■ Iterators	4-15
■ Implementation Issues	4-16
Support for Object-Oriented programming	4-17
■ Calling Mechanisms	4-17
■ Type Checking	4-18
■ Inheritance	4-19
■ Multiple Inheritance	4-20
■ Encapsulation	4-21
■ Implementation Issues	4-23
Limits to Perfection	4-23
Conclusions	4-24

---

<b>Footnotes</b>	4-25
------------------	------





# What is "Object-Oriented Programming"?



This chapter is taken directly from a paper by Bjarne Stroustrup.

## Abstract

"Object-Oriented Programming" and "Data Abstraction" have become very common terms. Unfortunately, few people agree on what they mean. I will offer informal definitions that appear to make sense in the context of languages like Ada, C++, Modula-2, Simula, and Smalltalk. The general idea is to equate "support for data abstraction" with the ability to define and use new types and equate "support for object-oriented programming" with the ability to express type hierarchies. Features necessary to support these programming styles in a general purpose programming language will be discussed. The presentation centers around C++ but is not limited to facilities provided by that language.

## Introduction

Not all programming languages can be "object oriented." Yet claims have been made to the effect that APL, Ada, Clu, C++, LOOPS, and Smalltalk are object-oriented programming languages. I have heard discussions of object-oriented design in C, Pascal, Modula-2, and CHILL. Could there somewhere be proponents of object-oriented Fortran and Cobol programming? I think there must be. "Object-oriented" has in many circles become a high-tech synonym for "good," and when you examine discussions in the trade press, you can find arguments that appear to boil down to syllogisms like:

Ada is good Object oriented is good ----- Ada is object oriented
---

This paper presents one view of what "object oriented" ought to mean in the context of a general purpose programming language.

- distinguishes "object-oriented programming" and "data abstraction" from each other and from other programming styles and presents the mechanisms that are essential for supporting the various styles of programming
- presents features needed to make data abstraction effective
- discusses facilities needed to support object-oriented programming
- presents some limits imposed on data abstraction and object-oriented programming by traditional hardware architectures and operating systems

Examples will be presented in C++. The reason for this is partly to introduce C++ and partly because C++ is one of the few languages that supports both data abstraction and object-oriented programming in addition to traditional programming techniques. Issues of concurrency and of hardware support for specific higher-level language constructs are ignored in this paper.

## Programming Paradigms

Object-oriented programming is a technique for programming — a paradigm for writing “good” programs for a set of problems. If the term “object-oriented programming language” means anything it must mean a programming language that provides mechanisms that support the object-oriented style of programming well.

There is an important distinction here. A language is said to *support* a style of programming if it provides facilities that make it convenient (reasonably easy, safe, and efficient) to use that style. A language does not support a technique if it takes exceptional effort or exceptional skill to write such programs; it merely *enables* the technique to be used. For example, you can write structured programs in Fortran, write type-secure programs in C, and use data abstraction in Modula-2, but it is unnecessarily hard to do because these languages do not support those techniques.

Support for a paradigm comes not only in the obvious form of language facilities that allow direct use of the paradigm, but also in the more subtle form of compile-time and/or run-time checks against unintentional deviation from the paradigm. Type checking is the most obvious example of this; ambiguity detection and run-time checks can be used to extend linguistic support for paradigms. Extra-linguistic facilities such as standard libraries and programming environments can also provide significant support for paradigms.

A language is not necessarily better than another because it possesses a feature the other does not. There are many examples to the contrary. The important issue is not so much what features a language possesses but that the features it does possess are sufficient to support the desired programming styles in the desired application areas:

- all features must be cleanly and elegantly integrated into the language
- it must be possible to use features in combination to achieve solutions that would otherwise have required extra separate features
- there should be as few spurious and “special purpose” features as possible
- a feature should be such that its implementation does not impose significant overheads on programs that do not require it
- a user need only know about the subset of the language explicitly used to write a program

The last two principles can be summarized as “what you don’t know won’t hurt you.” If there are any doubts about the usefulness of a feature it is better left out. It is *much* easier to add a feature to a language than to remove or modify one that has found its way into the compilers or the literature.

I will now present some programming styles and the key language mechanisms necessary for supporting them. The presentation of language features is not intended to be exhaustive.

### Procedural Programming

The original (and probably still the most commonly used) programming paradigm is:

*Decide which procedures you want;  
use the best algorithms you can find.*

The focus is on the design of the processing, the algorithm needed to perform the desired computation. Languages support this paradigm by facilities for passing arguments to functions and returning values from functions. The literature related to this way of thinking is filled with discussion of ways of passing arguments, ways of distinguishing different kinds of arguments, different kinds of functions (procedures, routines, macros, ...), etc. Fortran is the original procedural language; Algol60, Algol68, C, and Pascal are later inventions in the same tradition.

A typical example of "good style" is a square root function. It neatly produces a result given an argument. To do this, it performs a well understood mathematical computation:

```
double sqrt(double arg)
{
    // the code for calculating a square root
}

void some_function()
{
    double root2 = sqrt(2);
    // ...
}
```

From a program organization point of view, functions are used to create order in a maze of algorithms.

## Data Hiding

Over the years, the emphasis in the design of programs has shifted away from the design of procedures towards the organization of data. Among other things, this reflects an increase in the program size. A set of related procedures with the data they manipulate is often called a *module*. The programming paradigm becomes:

*Decide which modules you want;  
partition the program so that data is hidden in modules.*

This paradigm is also known as the "data hiding principle." Where there is no grouping of procedures with related data the procedural programming style suffices. In particular, the techniques for designing "good procedures" are now applied for each procedure in a module. The most common example is a definition of a stack module. The main problems that have to be solved for a good solution are:

- provide a user interface for the stack (for example, functions `push()` and `pop()`)
- ensure that the representation of the stack (for example, a vector of elements) can only be accessed through this user interface
- ensure that the stack is initialized before its first use

Here is a plausible external interface for a stack module:

```
// declaration of the interface of module stack of characters
char pop();
void push(char);
const stack_size = 100;
```

Assuming that this interface is found in a file called stack.h, the "internals" can be defined like this:

```
#include "stack.h"
static char v[stack_size]; // ``static`` means local to this file/module
static char* p = v;       // the stack is initially empty

char pop()
{
    // check for underflow and pop
}

void push(char c)
{
    // check for overflow and push
}
```

It would be quite feasible to change the representation of this stack to a linked list. A user does not have access to the representation anyway (since `v` and `p` were declared `static`, that is local to the file/module in which they were declared). Such a stack can be used like this:

```
#include "stack.h"

void some_function()
{
    char c = pop(push('c'));
    if (c != 'c') error("impossible");
}
```

Pascal (as originally defined) doesn't provide any satisfactory facilities for such grouping: the only mechanism for hiding a name from "the rest of the program" is to make it local to a procedure. This leads to strange procedure nestings and over-reliance on global data.

C fares somewhat better. As shown in the example above, you can define a "module" by grouping related function and data definitions together in a single source file. The programmer can then control which names are seen by the rest of the program (a name can be seen by the rest of the program *unless* it has been declared `static`). Consequently, in C you can achieve a degree of modularity. However, there is no generally accepted paradigm for using this facility and the technique of relying on `static` declarations is rather low level.

One of Pascal's successors, Modula-2, goes a bit further. It formalizes the concept of a module, making it a fundamental language construct with well defined module declarations, explicit control of the scopes of names (import/export), a module initialization mechanism, and a set of generally known and accepted styles of usage.

The differences between C and Modula-2 in this area can be summarized by saying that C only *enables* the decomposition of a program into modules, while Modula-2 *supports* that technique.

## Data Abstraction

Programming with modules leads to the centralization of all data of a type under the control of a type manager module. If one wanted two stacks, one would define a stack manager module with an interface like this:

```
class stack_id; // stack_id is a type
                // no details about stacks or stack_ids are known here

stack_id create_stack(int size); // make a stack and return its identifier
destroy_stack(stack_id);        // call when stack is no longer needed

void push(stack_id, char);
char pop(stack_id);
```

This is certainly a great improvement over the traditional unstructured mess, but “types” implemented this way are clearly very different from the built-in types in a language. Each type manager module must define a separate mechanism for creating “variables” of its type, there is no established norm for assigning object identifiers, a “variable” of such a type has no name known to the compiler or programming environment, nor do such “variables” obey the usual scope rules or argument passing rules.

A type created through a module mechanism is in most important aspects different from a built-in type and enjoys support inferior to the support provided for built-in types. For example:

```
void f()
{
    stack_id s1;
    stack_id s2;

    s1 = create_stack(200);
    // Oops: forgot to create s2

    char c1 = pop(s1, push(s1, 'a'));
    if (c1 != 'c') error("impossible");

    char c2 = pop(s2, push(s2, 'a'));
    if (c2 != 'c') error("impossible");

    destroy(s2);
    // Oops: forgot to destroy s1
}
```

In other words, the module concept that supports the data hiding paradigm enables this style of programming, but it does not support it.

Languages such as Ada, Clu, and C++ attack this problem by allowing a user to define types that behave in (nearly) the same way as built-in types. Such a type is often called an *abstract data type*.<sup>1</sup> The programming paradigm becomes:

*Decide which types you want;  
provide a full set of operations for each type.*

Where there is no need for more than one object of a type the data hiding programming style using modules suffices. Arithmetic types such as rational and complex numbers are common examples of user defined types:

```
class complex {
    double re, im;
public:
    complex(double r, double i) { re=r; im=i; }
    complex(double r) { re=r; im=0; } // float->complex conversion

    friend complex operator+(complex, complex);
    friend complex operator-(complex, complex); // binary minus
    friend complex operator-(complex); // unary minus
    friend complex operator*(complex, complex);
    friend complex operator/(complex, complex);
    // ...
}
```

The declaration of class (that is, user defined type) `complex` specifies the representation of a complex number and the set of operations on a complex number. The representation is *private*; that is, `re` and `im` are accessible only to the functions specified in the declaration of class `complex`. Such functions can be defined like this:

```
complex operator+(complex a1, complex a2)
{
    return complex(a1.re+a2.re, a1.im+a2.im);
}
```

and used like this:

```
complex a = 2.3;
complex b = 1/a;
complex c = a+b*complex(1,2.3);
// ...
c = -(a/b)+2;
```

Most, but not all, modules are better expressed as user defined types. For concepts where the "module representation" is desirable even when a proper facility for defining types is available, the programmer can declare a type and only a single object of that type. Alternatively, a language might provide a module concept in addition to and distinct from the class concept.

## Problems with Data Abstraction

An abstract data type defines a sort of black box. Once it has been defined, it does not really interact with the rest of the program. There is no way of adapting it to new uses except by modifying its definition. This can lead to severe inflexibility. Consider defining a type shape for use in a graphics system. Assume for the moment that the system has to support circles, triangles, and squares. Assume also that you have some classes:

```
class point{ /* ... */ };
class color{ /* ... */ };
```

You might define a shape like this:

```
enum kind { circle, triangle, square };

class shape {
    point center;
    color col;
    kind k;
    // representation of shape
public:
    point where()      { return center; }
    void move(point to) { center = to; draw(); }
    void draw();
    void rotate(int);
    // more operations
};
```

The "type field" `k` is necessary to allow operations such as `draw()` and `rotate()` to determine what kind of shape they are dealing with (in a Pascal-like language, one might use a variant record with tag `k`). The function `draw()` might be defined like this:

```
void shape::draw()
{
    switch (k) {
        case circle:
            // draw a circle
            break;
        case triangle:
            // draw a triangle
            break;
        case square:
            // draw a square
    }
}
```

This is a mess. Functions such as `draw()` must "know about" all the kinds of shapes there are. Therefore the code for any such function grows each time a new shape is added to the system. If you define a new shape, every operation on a shape must be examined and (possibly) modified. You are not able to add a new shape to a system unless you have access to the source code for every operation. Since adding a new shape involves "touching" the code of every important operation on shapes, it requires great skill and potentially introduces bugs into the code handling other (older) shapes. The choice of representation of particular shapes can get severely cramped by the requirement that (at least some of)

their representation must fit into the typically fixed sized framework presented by the definition of the general type shape.

## Object-Oriented Programming

The problem is that there is no distinction between the general properties of any shape (a shape has a color, it can be drawn, etc.) and the properties of a specific shape (a circle is a shape that has a radius, is drawn by a circle-drawing function, etc.). Expressing this distinction and taking advantage of it defines object-oriented programming. A language with constructs that allow this distinction to be expressed and used supports object-oriented programming. Other languages don't.

The Simula inheritance mechanism provides a solution. First, specify a class that defines the general properties of all shapes:

```
class shape {
    point center;
    color col;
    // ...
public:
    point where() { return center; }
    void move(point to) { center = to; draw(); }
    virtual void draw();
    virtual void rotate(int);
    // ...
};
```

The functions for which the calling interface can be defined, but where the implementation cannot be defined except for a specific shape, have been marked "virtual" (the Simula and C++ term for "may be re-defined later in a class derived from this one"). Given this definition, we can write general functions manipulating shapes:

```
void rotate_all(shape* v, int size, int angle)
// rotate all members of vector "v" of size "size" "angle" degrees
{
    for (int i = 0; i < size; i++) v[i].rotate(angle);
}
```

To define a particular shape, we must say that it is a shape and specify its particular properties (including the virtual functions).

```
class circle : public shape {
    int radius;
public:
    void draw() { /* ... */ };
    void rotate(int) {} // yes, the null function
};
```

In C++, class circle is said to be *derived* from class shape, and class shape is said to be a *base* of class circle. An alternative terminology calls circle and shape subclass and superclass, respectively.



The programming paradigm is:

*Decide which classes you want;  
provide a full set of operations for each class;  
make commonality explicit by using inheritance.*

Where there is no such commonality data abstraction suffices. The amount of commonality between types that can be exploited by using inheritance and virtual functions is the litmus test of the applicability of object-oriented programming to an application area. In some areas, such as interactive graphics, there is clearly enormous scope for object-oriented programming. For other areas, such as classical arithmetic types and computations based on them, there appears to be hardly any scope for more than data abstraction and the facilities needed for the support of object-oriented programming seem unnecessary.<sup>2</sup>

Finding commonality among types in a system is not a trivial process. The amount of commonality to be exploited is affected by the way the system is designed. When designing a system, commonality must be actively sought, both by designing classes specifically as building blocks for other types, and by examining classes to see if they exhibit similarities that can be exploited in a common base class.

## Support for Data Abstraction

The basic support for programming with data abstraction consists of facilities for defining a set of operations for a type and for restricting the access to objects of the type to that set of operations. Once that is done, however, the programmer soon finds that language refinements are needed for convenient definition and use of the new types. Operator overloading is a good example of this.

### Initialization and Cleanup

When the representation of a type is hidden some mechanism must be provided for a user to initialize variables of that type. A simple solution is to require a user to call some function to initialize a variable before using it. For example:

```
class vector {
    int sz;
    int* v;
public:
    void init(int size); // call init to initialize sz and v
                        // before the first use of a vector

    // ...
};

vector v;
// don't use v here
v.init(10);
// use v here
```

This is error prone and inelegant. A better solution is to allow the designer of a type to provide a distinguished function to do the initialization. Given such a function, allocation and initialization of a

variable becomes a single operation (often called instantiation) instead of two separate operations. Such an initialization function is often called a constructor. In cases where construction of objects of a type is non-trivial, one often needs a complementary operation to clean up objects after their last use. In C++, such a cleanup function is called a destructor. Consider a vector type:

```
class vector {
    int sz;           // number of elements
    int* v;          // pointer to integers
public:
    vector(int);     // constructor
    ~vector();       // destructor
    int& operator[](int index); // subscript operator
};
```

The vector constructor can be defined to allocate space like this:

```
vector::vector(int s)
{
    if (s<=0) error("bad vector size");
    sz = s;
    v = new int[s]; // allocate an array of "s" integers
}
```

The vector destructor frees the storage used:

```
vector::~~vector()
{
    delete v; // deallocate the memory pointed to by v
}
```

C++ does not support garbage collection. This is compensated for, however, by enabling a type to maintain its own storage management without requiring intervention by a user. This is a common use for the constructor/destructor mechanism, but many uses of this mechanism are unrelated to storage management.

## Assignment and Initialization

Controlling construction and destruction of objects is sufficient for many types, but not for all. It can also be necessary to control all copy operations. Consider class vector:

```
vector v1(100);
vector v2 = v1; // make a new vector v2 initialized to v1
v1 = v2;       // assign v2 to v1
```

It must be possible to define the meaning of the initialization of v2 and the assignment to v1. Alternatively it should be possible to prohibit such copy operations; preferably both alternatives should be available. For example:

```

class vector {
    int* v;
    int  sz;
public:
    // ...
    void operator=(vector&); // assignment
    vector(vector&);        // initialization
};

```

specifies that user defined operations should be used to interpret vector assignment and initialization. Assignment might be defined like this:

```

vector::operator=(vector& a) // check size and copy elements
{
    if (sz != a.sz) error("bad vector size for =");
    for (int i = 0; i<sz; i++) v[i] = a.v[i];
}

```

Since the assignment operation relies on the "old value" of the vector being assigned to, the initialization operation *must* be different. For example:

```

vector::vector(vector& a) // initialize a vector from another vector
{
    sz = a.sz; // same size
    v = new int[sz]; // allocate element array
    for (int i = 0; i<sz; i++) v[i] = a.v[i]; // copy elements
}

```

In C++, a constructor of the form `X(X&)` defines all initialization of objects of type `X` with another object of type `X`. In addition to explicit initialization constructors of the form `X(X&)` are used to handle arguments passed "by value" and function return values.

In C++ assignment of an object of class `X` can be prohibited by declaring assignment private:

```

class X {
    void operator=(X&); // only members of X can
    X(X&); // copy an X
    ...
public:
    ...
};

```

Ada does not support constructors, destructors, overloading of assignment, or user defined control of argument passing and function return. This severely limits the class of types that can be defined and forces the programmer back to "data hiding techniques"; that is, the user must design and use type manager modules rather than proper types.

## Parameterized Types

Why would you want to define a vector of integers anyway? A user typically needs a vector of elements of some type unknown to the writer of the vector type. Consequently the vector type ought to be expressed in such a way that it takes the element type as an argument:

```
class vector<class T> {      // vector of elements of type T
    T* v;
    int sz;
public:
    vector(int s)
    {
        if (s <= 0) error("bad vector size");
        v = new T[sz = s];    // allocate an array of "s" "T"s
    }
    T& operator[](int i);
    int size() { return sz; }
    // ...
};
```

Vectors of specific types can now be defined and used:

```
vector<int> v1(100);        // v1 is a vector of 100 integers
vector<complex> v2(200);   // v2 is a vector of 200 complex numbers

v2[i] = complex(v1[x],v1[y]);
```

Ada, Clu, and ML support parameterized types. Unfortunately, C++ does not; the notation is simply devised for illustration. Where needed, parameterized classes are "faked" using typedefs. There need not be any run-time overheads compared with a class where all types involved are specified directly.

Typically a parameterized type will have to depend on at least some aspect of a type parameter. For example, some of the vector operations must assume that assignment is defined for objects of the parameter type. How can one ensure that? One solution to this problem is to require the designer of the parameterized class to state the dependency. For example, "T must be a type for which = is defined." A better solution is not to or to take a specification of an argument type as a partial specification. A compiler can detect a "missing operation" if it is applied and give an error message such as:

```
cannot define vector(non_copy)::operator[](non_copy&) :
    type non_copy does not have operator=
```

This technique allows the definition of types where the dependency on attributes of a parameter type is handled at the level of the individual operation of the type. For example, one might define a vector with a sort operation. The sort operation might use <, ==, and = on objects of the parameter type. It would still be possible to define vectors of a type for which '<' was not defined as long as the vector sorting operation was not actually invoked.

A problem with parameterized types is that each instantiation creates an independent type. For example, the type vector<char> is unrelated to the type vector<complex>. Ideally one would like to be able to express and utilize the commonality of types generated from the same parameterized type. For example, both vector<char> and vector<complex> have a size() function that is independent of the

parameter type. It is possible, but not trivial, to deduce this from the definition of class `vector` and then allow `size()` to be applied to any `vector`. An interpreted language or a language supporting both parameterized types and inheritance has an advantage here.

## Exception Handling

As programs grow, and especially when libraries are used extensively, standards for handling errors (or more generally: "exceptional circumstances") become important. Ada, Algol68, and Clu each support a standard way of handling exceptions. Unfortunately, C++ does not. Where needed exceptions are "faked" using pointers to functions, "exception objects," "error states," and the C library `signal` and `longjmp` facilities. This is not satisfactory in general and fails even to provide a standard framework for error handling.

Consider again the `vector` example. What *ought* to be done when an out of range index value is passed to the subscript operator? The designer of the `vector` class should be able to provide a default behavior for this. For example:

```
class vector {
    ...
    except vector_range {
        // define an exception called vector_range
        // and specify default code for handling it
        error("global: vector range error");
        exit(99);
    }
}
```

Instead of calling an error function, `vector::operator[]()` can invoke the exception handling code, "raise the exception":

```
int& vector::operator[](int i)
{
    if (0<i || sz<=i) raise vector_range;
    return v[i];
}
```

This will cause the call stack to be unraveled until an exception handler for `vector_range` is found; this handler will then be executed.

An exception handler may be defined for a specific block:

```

void f() {
    vector v(10);
    try {
        // errors here are handled by the local
        // exception handler defined below
        // ...
        int i = g(); // g might cause a range error using some vector
        v[i] = 7;    // potential range error
    }
    except {
        vector::vector_range:
            error("f(): vector range error");
            return;
    }
    // errors here are handled by the global
    // exception handler defined in vector

    int i = g(); // g might cause a range error using some vector
    i] = 7;     // potential range error
}

```

There are many ways of defining exceptions and the behavior of exception handlers. The facility sketched here resembles the ones found in Clu and Modula-2+. This style of exception handling can be implemented so that code is not executed unless an exception is raised (except possibly for some initialization code at the start of a program) or portably across most C implementations by using `setjmp()` and `longjmp()`.<sup>3</sup>

Could exceptions, as defined above, be completely "faked" in a language such as C++? Unfortunately, no. The snag is that when an exception occurs, the run-time stack must be unraveled up to a point where a handler is defined. To do this properly in C++ involves invoking destructors defined in the scopes involved. This is not done by a C `longjmp()` and cannot in general be done by the user.

## Coercions

User-defined coercions, such as the one from floating point numbers to complex numbers implied by the constructor `complex(double)`, have proven unexpectedly useful in C++. Such coercions can be applied explicitly or the programmer can rely on the compiler to add them implicitly where necessary and unambiguous:

```

complex a = complex(1);
complex b = 1; // implicit: 1 -> complex(1)
a = b+complex(2);
a = b+2; // implicit: 2 -> complex(2)

```

Coercions were introduced into C++ because mixed mode arithmetic is the norm in languages for numerical work and because most user defined types used for "calculation" (for example matrices, character strings, and machine addresses) have natural mappings to and/or from other types.

One use of coercions has proven especially useful from a program organization point of view:

```

complex a = 2;
complex b = a+2; // interpreted as operator+(a,complex(2))
b = 2+a;        // interpreted as operator+(complex(2),a)

```

Only one function is needed to interpret “+” operations and the two operands are handled identically by the type system. Furthermore, class `complex` is written without any need to modify the concept of integers to enable the smooth and natural integration of the two concepts. This is in contrast to a “pure object-oriented system” where the operations would be interpreted like this:

```

a+2; // a.operator+(2)
2+a; // 2.operator+(a)

```

making it necessary to modify class `integer` to make `2+a` legal. Modifying existing code should be avoided as far as possible when adding new facilities to a system. Typically, object-oriented programming offers superior facilities for adding to a system without modifying existing code. In this case, however, data abstraction facilities provide a better solution.

## Iterators

It has been claimed that a language supporting data abstraction must provide a way of defining control structures. In particular, a mechanism that allows a user to define a loop over the elements of some type containing elements is often needed. This must be achieved without forcing a user to depend on details of the implementation of the user defined type. Given a sufficiently powerful mechanism for defining new types and the ability to overload operators, this can be handled without a separate mechanism for defining control structures.

For a vector, defining an iterator is not necessary since an ordering is available to a user through the indices. I’ll define one anyway to demonstrate the technique. There are several possible styles of iterators. My favorite relies on overloading the function application operator `()`:<sup>4</sup>

```

class vector_iterator {
    vector& v;
    int i;
public:
    vector_iterator(vector& r) { i = 0; v = r; }
    int operator() () { return i<v.size() ? v.elem(i++) : 0; }
};

```

A `vector_iterator` can now be declared and used for a vector like this:

```

vector v(sz);
vector_iterator next(v);
int i;
while (i=next()) print(i);

```

More than one iterator can be active for a single object at one time, and a type may have several different iterator types defined for it so that different kinds of iteration may be performed. An iterator is a rather simple control structure. More general mechanisms can also be defined. For example, the C++ standard library provides a co-routine class.

For many "container" types, such as `vector`, one can avoid introducing a separate iterator type by defining an iteration mechanism as part of the type itself. A `vector` might be defined to have a "current element":

```
class vector {
    int* v;
    int sz;
    int current;
public:
    // ...
    int next() { return (current++<sz) ? v[current] : 0; }
    int prev() { return (0<--current) ? v[current] : 0; }
};
```

Then the iteration can be performed like this:

```
vector v(sz);
int i;
while (i=v.next()) print(i);
```

This solution is not as general as the iterator solution, but avoids overhead in the important special case where only one kind of iteration is needed and where only one iteration at a time is needed for a `vector`. If necessary, a more general solution can be applied in addition to this simple one. Note that the "simple" solution requires more foresight from the designer of the container class than the iterator solution does. The iterator-type technique can also be used to define iterators that can be bound to several different container types thus providing a mechanism for iterating over different container types with a single iterator type.

## Implementation Issues

The support needed for data abstraction is primarily provided in the form of language features implemented by a compiler. However, parameterized types are best implemented with support from a linker with some knowledge of the language semantics, and exception handling requires support from the run-time environment. Both can be implemented to meet the strictest criteria for both compile time speed and efficiency without compromising generality or programmer convenience.

As the power to define types increases, programs to a larger degree depend on types from libraries (and not just those described in the language manual). This naturally puts greater demands on facilities to express what is inserted into or retrieved from a library, facilities for finding out what a library contains, facilities for determining what parts of a library are actually used by a program, etc.

For a compiled language facilities for calculating the minimal compilation necessary after a change become important. It is essential that the linker/loader is capable of bringing a program into memory for execution without also bringing in large amounts of related, but unused, code. In particular, a library/linker/loader system that brings the code for every operation on a type into core just because the programmer used one or two operations on the type is worse than useless.



## Support for Object-Oriented programming

The basic support a programmer needs to write object-oriented programs consists of a class mechanism with inheritance and a mechanism that allows calls of member functions to depend on the actual type of an object (in cases where the actual type is unknown at compile time). The design of the member function calling mechanism is critical. In addition, facilities supporting data abstraction techniques (as described above) are important because the arguments for data abstraction and for its refinements to support elegant use of types are equally valid where support for object-oriented programming is available. The success of both techniques hinges on the design of types and on the ease, flexibility, and efficiency of such types. Object-oriented programming simply allows user defined types to be far more flexible and general than the ones designed using only data abstraction techniques.

### Calling Mechanisms

The key language facility supporting object-oriented programming is the mechanism by which a member function is invoked for a given object. For example, given a pointer  $p$ , how is a call  $p \rightarrow f(\text{arg})$  handled? There is a range of choices.

In languages such as C++ and Simula, where static type checking is extensively used, the type system can be employed to select between different calling mechanisms. In C++, two alternatives are available:

- A normal function call: the member function to be called is determined at compile time (through a lookup in the compiler's symbol tables) and called using the standard function call mechanism with an argument added to identify the object for which the function is called. Where the "standard function call" is not considered efficient enough, the programmer can declare a function `inline` and the compiler will attempt to inline expand its body. In this way, one can achieve the efficiency of a macro expansion without compromising the standard function semantics. This optimization is equally valuable as a support for data abstraction.
- A virtual function call: The function to be called depends on the type of the object for which it is called. This type cannot in general be determined until run time. Typically, the pointer  $p$  will be of some base class  $B$  and the object will be an object of some derived class  $D$  (as was the case with the base class `shape` and the derived class `circle` above). The call mechanism must look into the object and find some information placed there by the compiler to determine which function  $f$  is to be called. Once that function is found, say `D::f`, it can be called using the mechanism described above. The name  $f$  is at compile time converted into an index into a table of pointers to functions. This virtual call mechanism can be made essentially as efficient as the "normal function call" mechanism. In the standard C++ implementation, only five additional memory references are used.

In languages with weak static type checking a more elaborate mechanism must be employed. What is done in a language like Smalltalk is to store a list of the names of all member functions (methods) of a class so that they can be found at run time:

- A method invocation: First the appropriate table of method names is found by examining the object pointed to by  $p$ . In this table (or set of tables) the string "f" is looked up to see if the object has an  $f()$ . If an  $f()$  is found it is called; otherwise some error handling takes place. This lookup differs from the lookup done at compiler time in a statically checked language in that the method invocation uses a method table for the actual object.

A method invocation is inefficient compared with a virtual function call, but more flexible. Since static

type checking of arguments typically cannot be done for a method invocation, the use of methods must be supported by dynamic type checking.

## Type Checking

The shape example showed the power of virtual functions. What, in addition to this, does a method invocation mechanism do for you? You can attempt to invoke *any* method for *any* object.

The ability to invoke any method for any object enables the designer of general purpose libraries to push the responsibility for handling types onto the user. Naturally this simplifies the design of libraries. For example:

```
class stack { // assume class any has a member next
    any* v;
    void push(any* p)
    {
        p->next = v;
        v = p;
    }
    any* pop()
    {
        if (v == 0) return error_obj;
        any* r = v;
        v = v->next;
        return r;
    }
};
```

It becomes the responsibility of the user to avoid type mismatches like this:

```
stack<any*> cs;

cs.push(new Saab900);
cs.push(new Saab37B);

plane* p = (plane*)cs.pop();
p->takeoff();

p = (plane*)cs.pop();
p->takeoff(); // Oops! Run time error: a Saab 900 is a car
// a car does not have a takeoff method.
```

An attempt to use a car as a plane will be detected by the message handler and an appropriate error handler will be called. However, that is only a consolation when the user is also the programmer. The absence of static type checking makes it difficult to guarantee that errors of this class are not present in systems delivered to end-users. Naturally, a language designed with methods and without static types can express this example with fewer keystrokes.

Combinations of parameterized classes and the use of virtual functions can approach the flexibility, ease of design, and ease of use of libraries designed with method lookup without relaxing the static type checking or incurring measurable run time overheads (in time or space). For example:

```

stack<plane*> cs;

cs.push(new Saab900); // Compile time error:
                      // type mismatch: car* passed, plane* expected

cs.push(new Saab37B);

plane* p = cs.pop();
p->takeoff(); // fine: a Saab 37B is a plane

p = cs.pop();
p->takeoff();

```

The use of static type checking and virtual function calls leads to a somewhat different style of programming than does dynamic type checking and method invocation. For example, a Simula or C++ class specifies a fixed interface to a set of objects (of any derived class) whereas a Smalltalk class specifies an initial set of operations for objects (of any subclass). In other words, a Smalltalk class is a minimal specification and the user is free to try operations not specified whereas a C++ class is an exact specification and the user is guaranteed that only operations specified in the class declaration will be accepted by the compiler.

## Inheritance

Consider a language having some form of method lookup without having an inheritance mechanism. Could that language be said to support object-oriented programming? I think not. Clearly, you could do interesting things with the method table to adapt the objects' behavior to suit conditions. However, to avoid chaos, there must be some systematic way of associating methods and the data structures they assume for their object representation. To enable a user of an object to know what kind of behavior to expect, there would also have to be some standard way of expressing what is common to the different behaviors the object might adopt. This "systematic and standard way" would be an inheritance mechanism.

Consider a language having an inheritance mechanism without virtual functions or methods. Could that language be said to support object-oriented programming? I think not: the shape example does not have a good solution in such a language. However, such a language would be noticeably more powerful than a "plain" data abstraction language. This contention is supported by the observation that many Simula and C++ programs are structured using class hierarchies without virtual functions. The ability to express commonality (factoring) is an extremely powerful tool. For example, the problems associated with the need to have a common representation of all shapes could be solved. No union would be needed. However, in the absence of virtual functions, the programmer would have to resort to the use of "type fields" to determine actual types of objects, so the problems with the lack of modularity of the code would remain.<sup>5</sup>

This implies that class derivation (subclassing) is an important programming tool in its own right. It can be used to support object-oriented programming, but it has wider uses. This is particularly true if one identifies the use of inheritance in object-oriented programming with the idea that a base class expresses a general concept of which all derived classes are specializations. This idea captures only part of the expressive power of inheritance, but it is strongly encouraged by languages where every member function is virtual (or a method). Given suitable controls of what is inherited (see *The C++ Programming Language*), class derivation can be a powerful tool for creating new types. Given a class, derivation can be used to add and/or subtract features. The relation of the resulting class to its base cannot always be completely described in terms of specialization; factoring may be a better term.

Derivation is another tool in the hands of a programmer and there is no foolproof way of predicting how it is going to be used — and it is too early (even after 20 years of Simula) to tell which uses are simply mis-uses.

## Multiple Inheritance

When a class **A** is a base of class **B**, a **B** inherits the attributes of an **A**; that is, a **B** is an **A** in addition to whatever else it might be. Given this explanation it seems obvious that it might be useful to have a class **B** inherit from two base classes **A1** and **A2**. This is called multiple inheritance.

A fairly standard example of the use of multiple inheritance would be to provide two library classes `displayed` and `task` for representing objects under the control of a display manager and co-routines under the control of a scheduler, respectively. A programmer could then create classes such as

```
class my_displayed_task : public displayed, public task {
    // my stuff
};

class my_task : public task { // not displayed
    // my stuff
};

class my_displayed : public displayed { // not a task
    // my stuff
};
```

Using (only) single inheritance only two of these three choices would be open to the programmer. This leads to either code replication or loss of flexibility — and typically both. In C++ this example can be handled as shown above with no significant overheads (in time or space) compared to single inheritance and without sacrificing static type checking.

Ambiguities are handled at compile time:

```
class A { public: f(); ... };
class B { public: f(); ... };
class C : public A, public B { ... };

void g() {
    C* p;
    p->f(); // error: ambiguous
}
```

In this, C++ differs from the object-oriented Lisp dialects that support multiple inheritance. In these Lisp dialects ambiguities are resolved by considering the order of declarations significant, by considering objects of the same name in different base classes identical, or by combining methods of the same name in base classes into a more complex method of the highest class.

In C++, one would typically resolve the ambiguity by adding a function:

```

class C : public A, public B {
public:
    f()
    {
        // C's own stuff
        A::f();
        B::f();
    }
    ...
}

```

In addition to this fairly straightforward concept of independent multiple inheritance there appears to be a need for a more general mechanism for expressing dependencies between classes in a multiple inheritance lattice. In C++, the requirement that a sub-object should be shared by all other sub-objects in a class object is expressed through the mechanism of a virtual base class:

```

class W { ... };

class Bwindow // window with border
: public virtual W
{ ... };

class Mwindow // window with menu
: public virtual W
{ ... };

class BMW // window with border and menu
: public Bwindow, public Mwindow
{ ... };

```

Here the (single) window sub-object is shared by the Bwindow and Mwindow sub-objects of a BMW. The Lisp dialects provide concepts of method combination to ease programming using such complicated class hierarchies. C++ does not.

## Encapsulation

Consider a class member (either a data member or a function member) that needs to be protected from "unauthorized access." What choices can be reasonable for delimiting the set of functions that may access that member? The "obvious" answer for a language supporting object-oriented programming is "all operations defined for this object"; that is, all member functions. A non-obvious implication of this answer is that there cannot be a complete and final list of all functions that may access the protected member since one can always add another by deriving a new class from the protected member's class and define a member function of that derived class. This approach combines a large degree of protection from accident (since you do not easily define a new derived class "by accident") with the flexibility needed for "tool building" using class hierarchies (since you can "grant yourself access" to protected members by deriving a class).

Unfortunately, the "obvious" answer for a language oriented towards data abstraction is different: "list the functions that need access in the class declaration." There is nothing special about these functions. In particular, they need not be member functions. A non-member function with access to private class members is called a **friend** in C++. Class `complex` above was defined using **friend** functions. It is sometimes important that a function may be specified as a **friend** in more than one class.

Having the full list of members and friends available is a great advantage when you are trying to understand the behavior of a type and especially when you want to modify it.

Here is an example that demonstrates some of the range of choices for encapsulation in C++:

```
class B {
    // class members are default private
    int i1;
    void f1();
protected:
    int i2;
    void f2();
public:
    int i3;
    void f3();

    friend void g(B*); // any function can be designated as a friend
};
```

Private and protected members are not generally accessible:

```
void h(B* p)
{
    p->f1(); // error: B::f1 is private
    p->f2(); // error: B::f2 is protected
    p->f3(); // fine: B::f1 is public
}
```

Protected members, but not private members, are accessible to members of a derived class:

```
class D : public B {
public:
    void g()
    {
        f1(); // error: B::f1 is private
        f2(); // fine: B::f2 is protected, but D is derived from B
        f3(); // fine: B::f1 is public
    }
};
```

Friend functions have access to private and protected members just like member functions:

```
void g(B* p)
{
    p->f1(); // fine: B::f1 is private, but g() is a friend of B
    p->f2(); // fine: B::f2 is protected, but g() is a friend of B
    p->f3(); // fine: B::f1 is public
}
```

Encapsulation issues increase dramatically in importance with the size of the program and with the number and geographical dispersion of its users. See *The C++ Programming Language* for more detailed discussions of language support for encapsulation.

## Implementation Issues

The support needed for object-oriented programming is primarily provided by the run-time system and by the programming environment. Part of the reason is that object-oriented programming builds on the language improvements already pushed to their limit to support for data abstraction so that relatively few additions are needed.<sup>6</sup>

The use of object-oriented programming blurs the distinction between a programming language and its environment further. Since more powerful special- and general-purpose user defined types can be defined their use pervades user programs. This requires further development of the run-time system, library facilities, debuggers, performance measuring, monitoring tools, etc. Ideally these are integrated into a unified programming environment. Smalltalk is the best example of this.

## Limits to Perfection

A major problem with a language defined to exploit the techniques of data hiding, data abstraction, and object-oriented programming is that to claim to be a general purpose programming language it must

- run on traditional machines
- coexist with traditional operating systems
- compete with traditional programming languages in terms of run time efficiency
- cope with every major application area

This implies that facilities must be available for effective numerical work (floating point arithmetic without overheads that would make Fortran appear attractive), and that facilities must be available for access to memory in a way that allows device drivers to be written. It must also be possible to write calls that conform to the often rather strange standards required for traditional operating system interfaces. In addition, it should be possible to call functions written in other languages from an object-oriented programming language and for functions written in the object-oriented programming language to be called from a program written in another language.

Another implication is that an object-oriented programming language cannot completely rely on mechanisms that cannot be efficiently implemented on a traditional architecture and still expect to be used as a general purpose language. A very general implementation of method invocation can be a liability unless there are alternative ways of requesting a service.

Similarly, garbage collection can become a performance and portability bottleneck. Most object-oriented programming languages employ garbage collection to simplify the task of the programmer and to reduce the complexity of the language and its compiler. However, it ought to be possible to use garbage collection in non-critical areas while retaining control of storage use in areas where it matters. As an alternative, it is feasible to have a language without garbage collection and then provide sufficient expressive power to enable the design of types that maintain their own storage. C++ is an example of this.

Exception handling and concurrency features are other potential problem areas. Any feature that is best implemented with help from a linker is likely to become a portability problem.

The alternative to having "low level" features in a language is to handle major application areas using separate "low level" languages.

### Conclusions

Object-oriented programming is programming using inheritance. Data abstraction is programming using user defined types. With few exceptions, object-oriented programming can and ought to be a superset of data abstraction. These techniques need proper support to be effective. Data abstraction primarily needs support in the form of language features and object-oriented programming needs further support from a programming environment. To be general purpose, a language supporting data abstraction or object-oriented programming must enable effective use of traditional hardware.



---

## Footnotes

1. I prefer the term "user defined type": "*Those types are not "abstract"; they are as real as int and float.*" — Doug McIlroy. An alternative definition of *abstract data types* would require a mathematical "abstract" specification of all types (both built-in and user defined). What are referred to as types in this paper would, given such a specification, be concrete specifications of such truly abstract entities.
2. However, more advanced mathematics may benefit from the use of inheritance: Fields are specializations of rings; vector spaces a special case of modules.
3. See the C library manual for your system.
4. This style also relies on the existence of a distinguished value to represent "end of iteration." Often, in particular for C++ pointer types, 0 can be used.
5. This is the problem with Simula's inspect statement and the reason it does not have a counterpart in C++.
6. This assumes that an object-oriented language does indeed support data abstraction. However, the support for data abstraction is often deficient in such languages. Conversely, languages that support data abstraction are typically deficient in their support of object-oriented programming.



---

# 5 Multiple Inheritance

---

<b>Multiple Inheritance for C++</b>	5-1
Abstract	5-1
Introduction	5-1
Multiple Inheritance	5-1
C++ Implementation Strategy	5-2
Multiple Base Classes	5-4
■ Object Layout	5-4
■ Member Function Call	5-5
■ Ambiguities	5-6
■ Casting	5-6
■ Zero Valued Pointers	5-7
Virtual Functions	5-8
■ Implementation	5-8
■ Ambiguities	5-9
Multiple Inclusions	5-10
■ Multiple Sub-objects	5-10
■ Naming	5-11
■ Casting	5-11
Virtual Base Classes	5-12
■ Representation	5-13
■ Virtual Functions	5-14
Constructors and Destructors	5-15
Visibility	5-17
Overheads	5-17
But is it Simple to Use?	5-18
Conclusions	5-19

---

<b>Footnotes</b>	5-20
------------------	------

---



---

# Multiple Inheritance for C++



This chapter is taken directly from a paper by Bjarne Stroustrup.

## Abstract

Multiple Inheritance is the ability of a class to have more than one base class (super class). In a language where multiple inheritance is supported a program can be structured as a set of inheritance lattices instead of (just) as a set of inheritance trees. This is widely believed to be an important structuring tool. It is also widely believed that multiple inheritance complicates a programming language significantly, is hard to implement, and is expensive to run. I will demonstrate that none of these last three conjectures are true.

## Introduction

This paper describes an implementation of a multiple inheritance mechanism for C++ (described in *The C++ Programming Language*). It provides only the most rudimentary explanation of what multiple inheritance is in general and what it can be used for. The particular variation of the general concept implemented here is primarily explained in terms of this implementation.<sup>1</sup>

First a bit of background on multiple inheritance and C++ implementation technique is presented, then the multiple inheritance scheme implemented for C++ is introduced in two stages:

- the basic scheme for multiple inheritance, the basic strategy for ambiguity resolution, and the way to implement virtual functions
- handling of classes included more than once in an inheritance lattice; the programmer has the choice whether a multiply included base class will result in one or more sub-objects being created

Finally, some the complexities and overheads introduced by this multiple inheritance scheme are summarized.

## Multiple Inheritance

Consider writing a simulation of a network of computers. Each node in the network is represented by an object of class `Switch`, each user or computer by an object of class `Terminal`, and each communication line by an object of class `Line`. One way to monitor the simulation (or a real network of the same structure) would be to display the state of objects of various classes on a screen. Each object to be displayed is represented as an object of class `Displayed`. Objects of class `Displayed` are under control of a display manager that ensures regular update of a screen and/or data base. The classes `Terminal` and `Switch` are derived from a class `Task` that provides the basic facilities for co-routine style behavior. Objects of class `Task` are under control of a task manager (scheduler) that manages the real processor(s).

Ideally `Task` and `Displayed` are classes from a standard library. If you want to display a terminal class `Terminal` must be derived from class `Displayed`. Class `Terminal`, however, is already derived from class `Task`. In a single inheritance language, such as C++ or Simula67, we have only two ways of solving this problem: deriving `Task` from `Displayed` or deriving `Displayed` from `Task`. Neither is ideal since they both create a dependency between the library versions of two fundamental and independent concepts. Ideally one would want to be able to choose between saying that a `Terminal` is a `Task` *and* a `Displayed`; that a `Line` is a `Displayed` *but not* a `Task`; and that a `Switch` is a `Task` *but not* a `Displayed`.

The ability to express this using a class hierarchy, that is, to derive a class from more than one base class, is usually referred to as *multiple inheritance*. Other examples involve the representation of various kinds of windows in a window system and the representation of various kinds of processors and compilers for a multi-machine, multi-environment debugger.

In general, multiple inheritance allows a user to combine independent (and not so independent) concepts represented as classes into a composite concept represented as a derived class. A common way of using multiple inheritance is for a designer to provide sets of base classes with the intention that a user creates new classes by choosing base classes from each of the relevant sets. Thus a programmer creates new concepts using a recipe like "pick an A and/or a B." In the window example, a user might specify a new kind of window by selecting a style of window interaction (from the set of interaction base classes) and a style of appearance (from the set of base classes defining display options). In the debugger example, a programmer would specify a debugger by choosing a processor and a compiler.

Given multiple inheritance and N concepts each of which might somehow be combined with one of M other concepts, we need N+M classes to represent all the combined concepts. Given only single inheritance, we need to replicate information and provide N+M+N\*M classes. Single inheritance handles cases where N==1 or M==1. The usefulness of multiple inheritance for avoiding replication hinges on the importance of examples where the values of N and M are both larger than 1. It appears that examples with N>=2 and M>=2 are not uncommon; the window and debugger examples described above will typically have both N and M larger than 2.

## C++ Implementation Strategy

Before discussing multiple inheritance and its implementation in C++ I will first describe the main points in the traditional implementation of the C++ single inheritance class concept.

An object of a C++ class is represented by a contiguous region of memory. A pointer to an object of a class points to the first byte of that region of memory. The compiler turns a call of a member function into an "ordinary" function call with an "extra" argument; that "extra" argument is a pointer to the object for which the member function is called.

Consider a simple class A:<sup>2</sup>

```
class A {
    int a;
    void f(int i);
};
```

An object of class A will look like this

```

|   int a;   |

```

No information is placed in an A except the integer a specified by the user. No information relating to (non-virtual) member functions is placed in the object.

A call of the member function A::f:

```

A* pa;
pa->f(2);

```

is transformed by the compiler into an "ordinary function call":

```

f__F1A(pa,2);

```

Objects of derived classes are composed by concatenating the members of the classes involved:

```

class A { int a; void f(int); };
class B : A { int b; void g(int); };
class C : B { int c; void h(int); };

```

Again, no "housekeeping" information is added, so an object of class C looks like this:

```

|   int a;   |
|   int b;   |
|   int c;   |

```

The compiler "knows" the position of all members in an object of a derived class exactly as it does for an object of a simple class and generates the same (optimal) code in both cases.

Implementing virtual functions involves a table of functions. Consider:

```

class A {
    int a;
    virtual void f(int);
    virtual void g(int);
    virtual void h(int);
};

class B : A { int b; void g(int); };
class C : B { int c; void h(int); };

```

In this case, a table of virtual functions, the vtbl, contains the appropriate functions for a given class and a pointer to it is placed in every object. A class C object looks like this:

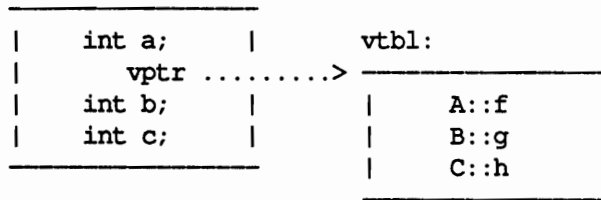

A call to a virtual function is transformed into an indirect call by the compiler. For example,

```
C* pc;  
pc->g(2);
```

becomes something like:

```
(* (pc->vptr[1])) (pc, 2);
```

A multiple inheritance mechanism for C++ must preserve the efficiency and the key features of this implementation scheme.

## Multiple Base Classes

Given two classes

```
class A { ... };  
class B { ... };
```

one can design a third using both as base classes:

```
class C : A , B { ... };
```

This means that a C is an A and a B. One might equivalently<sup>3</sup> define C like this:

```
class C : B , A { ... };
```

## Object Layout

An object of class C can be laid out as a contiguous object like this:



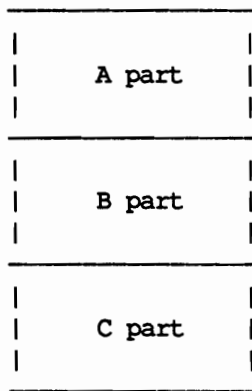

Accessing a member of classes A, B or C is handled exactly as before: the compiler knows the location in the object of each member and generates the appropriate code (without spurious indirections or other overhead).

### Member Function Call

Calling a member function of A or C is identical to what was done in the single inheritance case. Calling a member function of B given a C\* is slightly more involved:

```
C* pc;
pc->bf(2);           // assume that bf is a member of B
                    // and that C has no member named bf
                    // except the one inherited from B
```

Naturally, B::bf() expects a B\* (to become its this pointer). To provide it, a constant must be added to pc. This constant, delta(B), is the relative position of the B part of C. This delta is known to the compiler that transforms the call into:

```
bf__F1B( (B*) ((char*)pc+delta(B)), 2);
```

The overhead is one addition of a constant per call of this kind. During the execution of a member function of B the function's this pointer points to the B part of C:

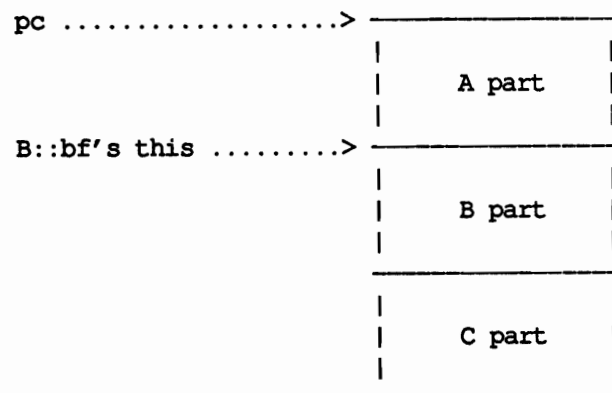

Note that there is no space penalty involved in using a second base class and that the minimal time penalty is incurred only once per call.

### Ambiguities

Consider potential ambiguities if both A and B have a public member `ii`:

```
class A { int ii; };
class B { char* ii; };
class C : A, B { };
```

In this case C will have two members called `ii`, `A::ii` and `B::ii`. Then

```
C* pc;
pc->ii;           // error: A::ii or B::ii ?
```

is illegal since it is ambiguous. Such ambiguities can be resolved by explicit qualification:

```
pc->A::ii;       // C's A's ii
pc->B::ii;       // C's B's ii
```

A similar ambiguity arises if both A and B have a function `f()`:

```
class A { void f(); };
class B { int f(); };
class C : A, B { };

C* pc;
pc->f();         // error: A::f or B::f ?

pc->A::f();     // C's A's f
pc->B::f();     // C's B's f
```

As an alternative to specifying which base class in each call of an `f()`, one might define an `f()` for C. `C::f()` might call the base class functions. For example:

```
class C : A, B {
    int f() { A::f(); return B::f(); }
};

C* pc;
pc->f();       // C::f is called
```

### Casting

Explicit and implicit casting may also involve modifying a pointer value with a delta:

```

C* pc;
B* pb;
pb = (B*)pc;      // pb = (B*) ((char*)pc+delta(B))
pb = pc;         // pb = (B*) ((char*)pc+delta(B))
pc = pb;         // error: cast needed
pc = (C*)pb;     // pc = (C*) ((char*)pb-delta(B))

```

Casting yields the pointer referring to the appropriate part of the same object.

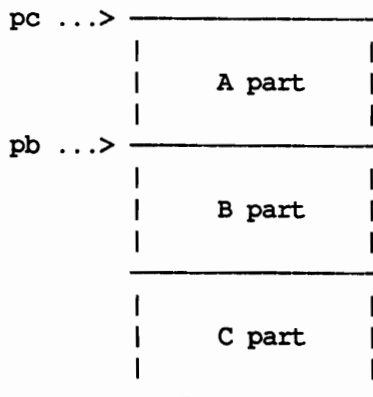

Comparisons are interpreted in the same way:

```

pc == pb;        // that is, pc == (C*)pb
                  // or equivalently (B*)pc == pb

                  // that is, (B*) ((char*)pc+delta(B)) == pb
                  // or equivalently pc == (C*) ((char*)pb-delta(B))

```

Note that in both C and C++ casting has always been an operator that produced one value given another rather than an operator that simply reinterpreted a bit pattern. For example, on almost all machines `(int).2` causes code to be executed; `(float)(int).2` is not equal to `.2`. Introducing multiple inheritance as described here will introduce cases where `(char*)(B*)v!=(char*)v` for some pointer type `B*`. Note, however, that when `B` is a base class of `C`, `(B*)v==(C*)v==v`.

### Zero Valued Pointers

Pointers with the value zero cause a separate problem in the context of multiple base classes. Consider applying the rules presented above to a zero-valued pointer:

```

C* pc = 0;
B* pb = 0;
if (pb == 0) ...
pb = pc;      // pb = (B*) ((char*)pc+delta(B))
if (pb == 0) ...

```

The second test would fail since `pb` would have the value `(B*)((char*)0+delta(B))`.

The solution is to elaborate the conversion (casting) operation to test for the pointer-value 0:

```
C* pc = 0;
B* pb = 0;
if (pb == 0) ...
pb = pc;          // pb = (pc==0)?0:(B*)((char*)pc+delta(B))
if (pb == 0) ...
```

The added complexity and run-time overhead are a test and an increment.

## Virtual Functions

Naturally, member functions may be virtual:

```
class A { virtual void f(); };
class B { virtual void f(); virtual void g(); };
class C : A , B { void f(); };
```

```
A* pa = new C;
B* pb = new C;
C* pc = new C;
```

```
pa->f();
pb->f();
pc->f();
```

All these calls will invoke `C::f()`. This follows directly from the definition of **virtual** since class **C** is derived from class **A** and from class **B**.

## Implementation

On entry to `C::f`, the `this` pointer must point to the beginning of the **C** object (and not to the **B** part). However, it is not in general known at compile time that the **B** pointed to by `pb` is part of a **C** so the compiler cannot subtract the constant `delta(B)`. Consequently `delta(B)` must be stored so that it can be found at run time. Since it is only used when calling a virtual function the obvious place to store it is in the table of virtual functions (`vtbl`). For reasons that will be explained below the `delta` is stored with each function in the `vtbl` so that a `vtbl` entry will be of the form:

```
struct vtbl_entry {
    void    (*fct) ();
    int     delta;
};
```

An object of class **C** will look like this:



could wonder why someone would want to both declare a function virtual and also call it using explicit qualification. If `f()` is virtual, adding an `f()` to the derived class is clearly the correct way of resolving the ambiguity.

The case where no `C::f` is declared cannot be handled by resolving ambiguities at the point of call. Consider:

```
class A { virtual void f(); };
class B { virtual void f(); };
class C : A , B { };           // error: C::f needed

C* pc = new C;
pc->f();                       // ambiguous

A* pa = pc;                   // implicit conversion of C* to A*
pa->f();                       // not ambiguous: calls A::f();
```

The potential ambiguity in a call of `f()` is detected at the point where the virtual function tables for `A` and `B` in `C` are constructed. In other words, the declaration of `C` above is illegal because it would allow calls, such as `pa->f()`, which are unambiguous *only* because type information has been “lost” through an implicit coercion; a call of `f()` for an object of type `C` is ambiguous.

## Multiple Inclusions

A class can have any number of base classes. For example,

```
class A : B1, B2, B3, B4, B5, B6 { ... };
```

It is illegal to specify the same class twice in a list of base classes. For example,

```
class A : B, B { ... };       // error
```

The reason for this restriction is that every access to a `B` member would be ambiguous and therefore illegal; this restriction also simplifies the compiler.

## Multiple Sub-objects

A class may be included more than once as a base class. For example:

```
class L { ... };
class A : L { ... };
class B : L { ... };
class C : A , B { ... };
```

In such cases multiple objects of the base class are part of an object of the derived class. For example, an object of class `C` has two `L`'s: one for `A` and one for `B`:

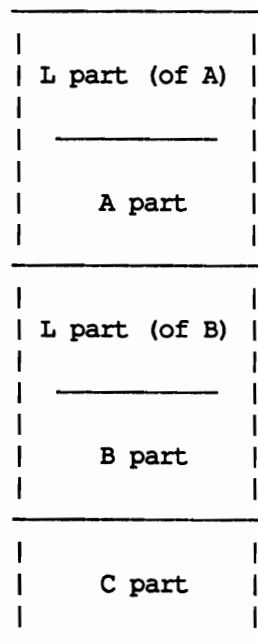

This can even be useful. Think of **L** as a link class for a Simula-style linked list. In this case a **C** can be on both the list of **A**s and the list of **B**s.

## Naming

Assume that class **L** in the example above has a member **m**. How could a function **C::f** refer to **L::m**? The obvious answer is "by explicit qualification":

```
void C::f() { A::m = B::m; }
```

This will work nicely provided neither **A** nor **B** has a member **m** (except the one they inherited from **L**). If necessary, the qualification syntax of C++ could be extended to allow the more explicit:

```
void C::f() { A::L::m = B::L::m; }
```

## Casting

Consider the example above again. The fact that there are two copies of **L** makes casting (both explicit and implicit) between **L\*** and **C\*** ambiguous, and consequently illegal:

```

C* pc = new C;
L* pl = pc;      // error: ambiguous
pl = (L*)pc;    // error: still ambiguous
pl = (L*)(A*)pc; // The L in C's A
pc = pl;        // error: ambiguous
pc = (L*)pl;    // error: still ambiguous
pc = (C*)(A*)pl; // The C containing A's L
  
```

I don't expect this to be a problem. The place where this will surface is in cases where **A**s (or **B**s) are handled by functions expecting an **L**; in these cases a **C** will not be acceptable despite a **C** being an **A**:

```
extern f(L*);      // some standard function

A aa;
C cc;

f(&aa);           // fine
f(&cc);           // error: ambiguous
f((A*)&cc);       // fine
```

Casting is used for explicit disambiguation.

## Virtual Base Classes

When a class **C** has two base classes **A** and **B** these two base classes give rise to separate sub-objects that do not relate to each other in ways different from any other **A** and **B** objects. I call this *independent multiple inheritance*. However, many proposed uses of multiple inheritance assume a dependence among base classes (for example, the style of providing a selection of features for a window described in this chapter under "Multiple Inheritance"). Such dependencies can be expressed in terms of an object shared between the various derived classes. In other words, there must be a way of specifying that a base class must give rise to only one object in the final derived class even if it is mentioned as a base class several times. To distinguish this usage from independent multiple inheritance such base classes are specified to be virtual:

```
class AW : virtual W { ... };
class BW : virtual W { ... };
class CW : AW , BW { ... };
```

A single object of class **W** is to be shared between **AW** and **BW**; that is, only one **W** object must be included in **CW** as the result of deriving **CW** from **AW** and **BW**. Except for giving rise to a unique object in a derived class, a virtual base class behaves exactly like a non-virtual base class.

The "virtualness" of **W** is a property of the derivation specified by **AW** and **BW** and not a property of **W** itself. Every virtual base in an inheritance DAG refers to the same object. This object is constructed once using a default constructor. A class that can only be constructed given an argument cannot be a virtual base.

A class may be both a normal and a virtual base in an inheritance DAG:

```
class A : virtual L { ... };
class B : virtual L { ... };
class C : A , B { ... };
class D : L, C { ... };
```

A **D** object will have two sub-objects of class **L**, one virtual and one "normal."



## Representation

The object representing a virtual base class W object cannot be placed in a fixed position relative to both AW and BW in all objects. Consequently, a pointer to W must be stored in all objects directly accessing the W object to allow access independently of its relative position. For example:

```
AW* paw = new AW;
BW* pbw = new BW;
CW* pcw = new CW;
```

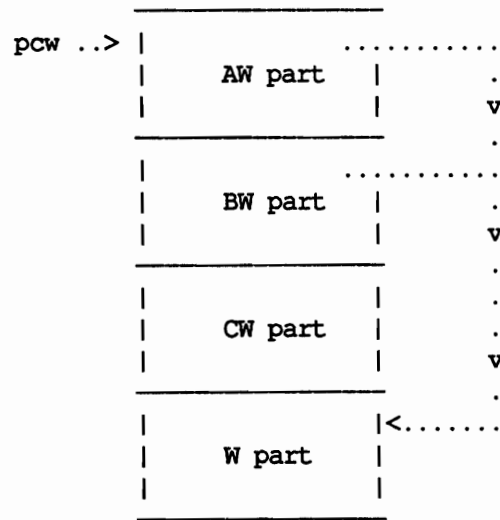
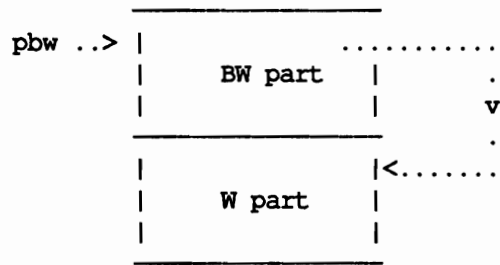
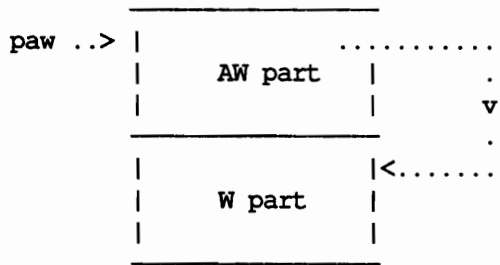

A class can have an arbitrary number of virtual base classes.

One can cast from a derived class to a virtual base class, but not from a virtual base class to a derived class. The former involves following the virtual base pointer; the latter cannot be done given the information available at run time. Storing a "back-pointer" to the enclosing object(s) is non-trivial in general and was considered unsuitable for C++ as was the alternative strategy of dynamically keeping track of the objects "for which" a given member function invocation operates.

### Virtual Functions

Consider:

```
class W {
    virtual void f();
    virtual void g();
    virtual void h();
    virtual void k();
    ...
};

class AW : virtual W { void g(); ... };
class BW : virtual W { void f(); ... };
class CW : AW , BW { void h(); ... };

CW* pcw = new CW;

pcw->f();          // BW::f()
pcw->g();          // AW::g()
pcw->h();          // CW::h()
((AW*)pcw)->f();  // BW::f();
```

A CW object might look like this:

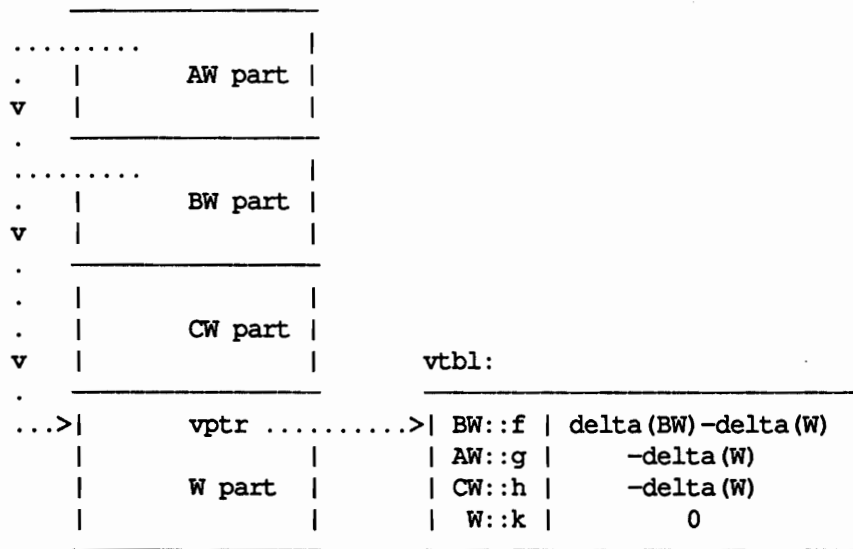

In general, the delta stored with a function pointer in a vtbl is the delta of the class defining the function minus the delta of the class for which the vtbl is constructed.

If W has a virtual function f that is re-defined in both AW and BW but not in CW an ambiguity results. Such ambiguities are easily detected at the point where CW's vtbl is constructed.

The rule for detecting ambiguities in a class lattice, or more precisely a directed acyclic graph (DAG) of classes, is that all re-definitions of a virtual function from a virtual base class must occur on a single path through the DAG. The example above can be drawn as a DAG like this:

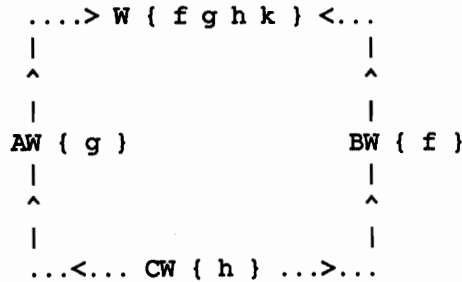

Note that a call "up" through one path of the DAG to a virtual function may result in the call of a function (re-defined) in another path (as happened in the call ((AW\*)pcw)->f() in the example above).

### Constructors and Destructors

Constructors for base classes are called before the constructor for their derived class. Destructors for base classes are called after the destructor for their derived class. Destructors are called in the reverse order of their declaration.

Arguments to base class constructors can be specified like this:

```
class A { A(int); };
class B { B(int); };
class C : A , virtual B {
    C(int a, int b) : A(a) , B(b) { ... }
};
```

Constructors are executed in the order their objects are declared. This rule is applied to members and base classes separately and the base class constructors and applied before the member constructors. When a class has more than one base class *all* argument lists for its base class constructor *must* be qualified with the name of the base class. This rule applies even if only one of the base classes actually requires arguments.

A virtual base is constructed before any of its derived classes. Virtual bases are constructed before any non-virtual bases and in the order they appear on a depth first left-to-right traversal of the inheritance DAG (directed acyclic graph). This rule applies recursively for virtual bases of virtual bases.

A virtual base is initialized by the “most derived” class of which it is a base. For example:

```
class V { public: V(); V(int); /* ... */ };
class A : public virtual V { public: A(); A(int); /* ... */ };
class B : public virtual V { public: B(); B(int); /* ... */ };
class C : public A, public B { public: C(); C(int); /* ... */ };
```

```
A::A(int i) : V(i) { /* ... */ }
B::B(int i) { /* ... */ }
C::C(int i) { /* ... */ }
```

```
V v(1);          // use V(int)
A a(2);         // use V(int)
B b(3);         // use V()
C c(4);         // use V()
```

The order of destructor calls is defined to be the reverse order of appearance in the class declaration (members before bases). There is no way for the programmer to control this order — except by the declaration order. A virtual base is destroyed after all of its derived classes.

Assignment to **this** in the constructor of a class that takes part in a multiple inheritance lattice is likely to lead to disaster. See Chapter 1 for alternatives.

## Visibility

The examples above ignored visibility considerations. A base class may be **public** or **private**. In addition, it may be **virtual**. For example:

```
class D
    : B1                // private (by default), non-virtual (by default)
    , virtual B2        // private (by default), virtual
    , public B3          // public, non-virtual (by default)
    , public virtual B4 {
    // ...
};
```

Note that a visibility or virtual specifier applies to a single base class only. For example,

```
class C : public A, B { ... };
```

declares a public base A and a private base B.

## Overheads

The overhead in using this scheme is:

1. one subtraction of a constant for each use of a member in a base class that is included as the second or subsequent base
2. one word per function in each vtbl (to hold the delta)
3. one memory reference and one subtraction for each call of a virtual function
4. one memory reference and one subtraction for access of a base class member of a virtual base class

Note that overheads [1] and [4] are only incurred where multiple inheritance is actually used, but overheads [2] and [3] are incurred for each class with virtual functions and for each virtual function call even when multiple inheritance is not used. Overheads [1] and [4] are only incurred when members of a second or subsequent base are accessed "from the outside"; a member function of a virtual base class does not incur special overheads when accessing members of its class.

This implies that except for [2] and [3] you pay only for what you actually use; [2] and [3] impose a minor overhead on the virtual function mechanism even where only single inheritance is used. This latter overhead could be avoided by using an alternative implementation of multiple inheritance, but I don't know of such an implementation that is also faster in the multiple inheritance case and as portable as the scheme described here.

Fortunately, these overheads are not significant. The time, space, and complexity overheads imposed on the compiler to implement multiple inheritance are not noticeable to the user.

### But is it Simple to Use?

What makes a language facility hard to use?

1. Lots of rules.
2. Subtle differences between rules.
3. Inability to automatically detect common errors.
4. Lack of generality.
5. Deficiencies.

The first two cases lead to difficulty of learning and remembering, causing bugs due to misuse and misunderstanding. The last two cases cause bugs and confusion as the programmer tries to circumvent the rules and "simulate" missing features. Case [3] causes frustration as the programmer discovers mistakes the hard way.

The multiple inheritance scheme presented here provides two ways of extending a class's name space:

- a base class
- a virtual base class

These are two ways of creating/specifying a new class rather than ways of creating two different kinds of classes. The rules for using the resulting classes do not depend on how the name space was extended:

- ambiguities are illegal
- rules for use of members are what they were for single inheritance
- visibility rules are what they were for single inheritance
- initialization rules are what they were for single inheritance

Violations of these rules are detected by the compiler.

In other words, the multiple inheritance scheme is only more complicated to use than the existing single inheritance scheme in that

- you can extend a class's name space more than once (with more than one base class)
- you can extend a class's name space in two ways rather than in only one way

This appears minimal and constitutes an attempt to provide a formal and (comparatively) safe set of mechanisms for observed practices and needs. I think that the scheme described here is "as simple as possible, but no simpler."

A potential source of problems exists in the absence of "system provided back-pointers" from a virtual base class to its enclosing object.

In some contexts, it might also be a problem that pointers to sub-objects are used extensively. This will affect programs that use explicit casting to non-object-pointer types (such as `char*`) and "extra linguistic" tools (such as debuggers and garbage collectors). Otherwise, and hopefully normally, all manipulation of object pointers follows the consistent rules explained previously and is invisible to the user.

## Conclusions

Multiple inheritance is reasonably simple to add to C++ in a way that makes it easy to use. Multiple inheritance is not too hard to implement, since it requires only very minor syntactic extensions, and fits naturally into the (static) type structure. The implementation is very efficient in both time and space. Compatibility with C is not affected. Portability is not affected.

---

## Footnotes

1. An earlier version of this paper was presented to the European UNIX Users' Group conference in Helsinki, May 1987. This paper has been revised to match the multiple inheritance scheme that was arrived at after further experimentation and thought. For more information see "The Evolution of C++: 1985-1987" and "What is 'Object-Oriented Programming?'"
2. In most of this paper data hiding issues are ignored to simplify the discussion and shorten the examples. This makes some examples illegal. Changing the word `class` to `struct` would make the examples legal, as would adding `public` specifiers in the appropriate places.
3. This definition is equivalent except for possible side effects in constructors and destructors (access to global variables, input operations, output operations, etc.).



---

# 6 Type-Safe Linkage for C++

---

<b>Type-safe Linkage for C++</b>	6-1
Abstract	6-1
Introduction	6-1
The Original Problem	6-1
The Original Solution	6-2
Problems with the Original Solution	6-2
■ The overload Linkage Problem	6-2
■ The General Linkage Problem	6-4
■ Combining Libraries	6-4
A General Solution	6-5
■ Type-safe C++ Linkage	6-6
■ Implicit Overloading	6-7
■ C Linkage	6-8
■ Caveat	6-9
Experience	6-10
■ Making Linkage Specifications Invisible	6-10
■ Error Handling	6-11
■ Upgrading Existing C++ Programs	6-12
Details	6-12
■ Default Linkage	6-12
■ Declarations in Different Scopes	6-13
■ Local Linkage Specification	6-14
Alternative Solutions	6-15
■ The Scope Trick	6-15
■ C "Storage Class"	6-15
■ Overload "Storage Class"	6-16
■ Calling Stubs	6-16
■ Encode Only C++ Functions	6-17
■ Nothing	6-18
Syntax Alternatives	6-18
■ Why <code>extern</code> ?	6-18
■ Linkage for Individual Functions	6-18
■ Linkage Pragmas	6-18
■ Special Linkage Blocks	6-19
Conclusions	6-20
■ The Function Name Encoding Scheme	6-20

---

## Footnotes

6-23



---

# Type-safe Linkage for C++



This chapter is taken directly from a paper by Bjarne Stroustrup.

## Abstract

This paper describes the problems involved in generating names for overloaded functions in C++ and in linking to C programs. It also discusses how these problems relate to library building. It presents a solution that provides a degree of type-safe linkage. This eliminates several classes of errors from C++ and allows libraries to be composed more freely than has hitherto been possible. Finally the current encoding scheme for C++ names is presented.

## Introduction

This paper describes the type-safe linkage scheme used by the 2.0 release of C++ and the mechanism provided to allow traditional (unsafe) linkage to non-C++ functions. It describes the problems with the scheme used by previous releases, the alternative solutions considered, and the practicalities involved in converting from the old linkage scheme to the new.

The new scheme makes the `overload` keyword redundant, simplifies the construction of tools operating on C++ object code, makes the composition of C++ libraries simpler and safer, and enables reliable detection of subtle program inconsistencies. The scheme does not involve any run-time costs and does not appear to add measurably to compile and link time.

The scheme is compatible with older C++ implementations for pure C++ programs but requires explicit specification of linkage requirements for linkage to non C++ functions.

## The Original Problem

C++ allows overloading of function names; that is, two functions may have the same name provided their argument types differ sufficiently for the compiler to tell them apart. For example,

```
double sqrt(double);
complex sqrt(complex);
```

Naturally, these functions must have different names in the object code produced from a C++ program. This is achieved by suffixing the name the user chose with an encoding of the argument types (the *signature* of the function). Thus the names of the two `sqrt()` functions become:

```
sqrt__Fd          // the sqrt that takes a double argument
sqrt__F7complex  // the sqrt that takes a complex argument
```

Some details of the encoding scheme are described under "The Function Name Encoding Scheme."

When experiments along this line began five years ago it was immediately noticed that for many sets of overloaded functions there was exactly one function of that name in the standard C library. Since C does not provide function name overloading there could not be two. It was deemed essential for C++ to be able to use the C libraries without modification, recompilation, or indirection. Thus the problem became to design an overloading facility for C++ that allowed calls to C library functions such as `sqrt()` even when the name `sqrt` was overloaded in the C++ program.

### The Original Solution

The solution, as used in all non-experimental C++ implementations up to now, was to let the name generated for a C++ function be the same as would be generated for a C function of the same name wherever possible. Thus `open()` gets the name `open` on systems where C doesn't modify its names on output, the name `_open` on systems where C prepends an underscore, etc.

This simple scheme clearly isn't sufficient to cope with overloaded functions. The keyword `overload` was introduced to distinguish the hard case from the easy one and also because function name overloading was considered a potentially dangerous feature that should not be accidentally or implicitly applied. In retrospect this was a mistake.

To allow linkage to C functions the rule was introduced that only the second and subsequent version of an overloaded function had their names encoded. Thus the programmer would write

```
overload sqrt;
double sqrt (double);           // sqrt
complex sqrt (complex);        // sqrt__F7complex
```

and the effect would be that the C++ compiler generated code referring to `sqrt` and `sqrt__F7complex`. This enabled a C++ programmer to use the C libraries. This trick solves the problems of name encoding, linkage to C, and protection against accidental overloading, but it is clearly a hack. Fortunately, it was only documented in the BUGS section of the C++ manual page.

### Problems with the Original Solution

There are at least three problems with this scheme:

- how to name overloaded functions so that one may be a C function
- how to detect errors caused by inconsistent function declarations
- how to specify libraries so that several libraries can be easily used together

### The overload Linkage Problem

Consider a program that uses an overloaded function `print()` to output globs and widgets. Naturally globs are defined in `glob.h` and widgets in `widget.h`. A user writes

```
// file1.c:
#include <glob.h>
#include <widget.h>
```

but this elicits an error message from the C++ compiler since `print()` is declared twice with different argument types. The user then modifies the program to read

```
// file1.c:
overload print;
#include <glob.h>
#include <widget.h>
```

and all is well until someone in some other part of the program writes

```
// file2.c:
overload print;
#include <widget.h>
#include <glob.h>
```

This fails to link since `file1.c`'s output refers to `print` (meaning `print(glob)`) and `print__F6widget`, whereas `file2.c`'s output refers to `print` (meaning `print(widget)`) and `print__F4glob`.

This is of course a nuisance, but at least the program fails to link and the programmer can — after some detective work based on relatively uninformative linker error messages — fix the problem. The nastier variation of this will happen to the conscientious programmer who knows that `print()` is overloaded and inserts the appropriate `overload` declarations, but happens to use only one variation of `print()` in each of two source files:

```
// file1.c:
overload print;
#include <glob.h>

// file2.c:
overload print;
#include <widget.h>
```

The output from `file1.c` and `file2.c` now both refer to `print`. Unfortunately, in the output from `file1.c` `print` means `print(glob)` whereas `print` refers to `print(widget)` in the output from `file2.c`. One might expect linkage to fail because `print()` has been defined twice. However, on most systems this is not what happens in the important case where the definitions of `print(glob)` and `print(widget)` are placed in libraries. Then, the linker simply picks the first definition of `print()` it encounters and ignores the second. The net effect is that calls (silently) go to the wrong version of `print()`. If we are lucky, the program will fail miserably (core dump); if not, we will simply get wrong results.

The requirement that the `overload` keyword must be used explicitly and the non-uniform treatment of overloaded functions (“the first overloaded function has C linkage”) is a cause of complexity in C++ compilers and in other tools that deal with C++ program text or with object code generated by a C++ compiler.

## The General Linkage Problem

This problem of inconsistent linkage is a variation of the general problem that C provides only the most rudimentary facilities for ensuring consistent linkage. For example, even in ANSI C and in C++ (until now) the following example will compile and link without warning:

```
#include <stdio.h>
extern int sqrt(int);

main()
{
    printf("sqrt(%d) = %d\n", 2, sqrt(2));
}
```

and produce output like this

```
sqrt(2) = 0
```

because even though the user clearly specified that an integer `sqrt()` was to be used, the C compiler/linker uses the double precision floating point `sqrt()` from the standard library. This problem can be handled by consistent and comprehensive use of correct and complete header files. However, that is not an easy thing to achieve reliably and is not standard practice. The traditional C and C++ compiler/linker systems do not provide the programmer with any help in detecting errors, oversights, or dangerous practices.

These linkage problems are especially nasty because they increase disproportionately with the size of programs and with the amount of library use.

## Combining Libraries

The standard header `complex.h` overloads `sqrt()`:

```
// complex.h:
overload sqrt;
#include <math.h>
complex sqrt(complex);
```

Some other header, `3d.h`, declares `sqrt()` without overloading it:

```
// 3d.h:
#include <math.h>
```

Now a user wants both the 3d and the complex number packages in a program:

```
#include <3d.h>
#include <complex.h>
```

Unfortunately this does not compile because this sequence of operations:

```
double sqrt(double);    // from <3d.h>
overload sqrt;         // from <math.h> via <complex.h>
```

A function must be overloaded before its first declaration is processed. So the programmer, who really did not want to know about the internals of those headers, must reorder the `#include` directives to get the program to compile:

```
#include <complex.h>
#include <3d.h>
```

This will work unless `3d.h` overloads some function, say `atan()`, that `complex.h` does not. Even in that case the programmer can cope with the problem by adding sufficient `overload` declarations where `3d.h` and `complex.h` are included:

```
overload sqrt;
overload atan;
#include <3d.h>
#include <complex.h>
```

This reordering and/or adding of `overload` declarations is work that is really quite spurious and in any case irrelevant to the job the programmer is trying to do. Worse, if the extra `overload` declarations were placed in a header file the programmer has now set the scene for the users of the new package to have exactly the same problems when they try combining this new library with other libraries. It becomes tempting to overload all functions or at least to provide header files that overload all interesting functions. This again defeats any real or imagined benefits of requiring explicit `overload` declarations.

## A General Solution

The overloading scheme used for C++ (until now) interacts with the traditional C linkage scheme in ways that bring out the worst in both. Overloading of function names that was introduced to provide notational convenience for programmers is becoming a noticeable source of extra work and complexity for builders and users of libraries. Either the idea of overloading is bad or else its implementation in C++ is deficient. The insecure C linkage scheme is a source of subtle and not-so-subtle errors. In summary:

- lack of type checking in the linker causes problems
- use of the `overload` keyword causes problems
- we must be able to link C++ and C program fragments

A solution to 1 is to augment the name of *every* function with an encoding of its signature. A solution to 2 is to cease to require the use of `overload` (and eventually abolish it completely). A solution to 3 is to require a C++ programmer to state explicitly when a function is supposed to have C-style linkage.

The question is whether a solution based on these three premises can be implemented without noticeable overhead and with only minimal inconvenience to C++ programmers. The ideal solution would

- require no C++ language changes
- provide type-safe linkage
- allow for simple and convenient linkage to C
- not break existing C++ code
- allow use of (ANSI style) C headers
- provide good error detection and error reporting
- be a good tool for library building
- not impose run-time overhead
- not impose compile time overhead

We have not been able to devise a scheme that fulfills all of these criteria strictly, but the adopted scheme is a good approximation.

### Type-safe C++ Linkage

First of all, every C++ function name is encoded by appending its signature. This ensures that a program will only load provided every function that is called has a definition and that the type specified at the point of call is the same as the type specified at the point of definition. For example, given:

```
f(int i) { ... }           // f_Fi
f(int i, char* j) { ... } // f_FiPc
```

These examples will cause correct linkage:

```
extern f(int);           // f_Fi - links to f(int)
f(1);

extern f(int, char*);   // f_FiPc - links to f(int, char*)
f(1, "asdf");
```

These examples will cause linkage errors independent of where in the program they occur because no `f()` with a suitable signature has been defined:

```
// no declaration of f() in this file
// (this is only legal in C programs)
f(1);           // f - links to ???

extern f(char*); // f_FPc - links to ???
f("asdf");

extern f(int ...); // f_Fie - links to ???
f(1, "asdf");
```

One might consider extending this encoding scheme to include global variables, etc., but this does not appear to be a good idea since that would introduce at least as many problems as it would solve. For example:



```

// file1.c:
int aa = 1;
extern int bb;

//file2.c:
char* aa = "asdf"; // error: aa is declared int in file1.c
extern char* bb; // error: bb is declared int in file1.c

```

Under the current C scheme, the double definition of `aa` will be caught and the inconsistent declarations of `bb` will not. Using an encoding scheme, the double definition of `aa` would not be caught since the difference in encoding would cause *two* differently named objects to be created — contrary to the rules of C and C++. The fact that the inconsistent declarations of `bb` would be caught by some linkers (not all) does not compensate for the incorrect linkage of `aa`. Consequently only functions are encoded using their signatures.

This linkage scheme is much safer than what is currently used for C, but it is not meant to solve all linkage problems. For example, if two libraries each provides a function `f(int)` as part of their public interface there is no mechanism that allows the compiler to detect that there are supposed to be two different `f(int)`s. If the `.o` files are loaded together the linker will detect the error, but where a library search mechanism is employed the error may go undetected.

Note that this linking scheme simply enforces the C++ rules that every function must be declared before it is called and that every declaration of an external name in C++ must have exactly the same type.

In essence, we use the name encoding scheme to “trick” the linker into doing type checking of the separately compiled files. More comprehensive solutions can be achieved by modifying the linker to understand C++ types. For example, a linker could check the types of global data objects and might also be able to provide features for ensuring the consistency of global constants and classes. However, getting an improved linker into use is typically a hard and slow process. The scheme presented here is portable across a great range of systems and can be used immediately.

## Implicit Overloading

If a function is declared twice with different argument types it is overloaded. For example:

```

double sqrt(double);
complex sqrt(complex);

```

is accepted without any explicit **overload** declaration. Naturally, **overload** declarations will be accepted in the foreseeable future; they are simply not necessary any more.

Does this relaxation of the C++ rules cause new problems? It does not appear to be the case. For example, originally I imagined that obvious mistakes such as

```

double sqrt(double); // sqrt__Fd
double d = sqrt(2.3);

double sqrt(int d) { ... } // sqrt__Fi

```

would cause hard-to-find errors. It certainly would with the traditional C linkage rules, but with type-safe linkage the program simply will not link because there is no function called `sqrt__Fd` defined anywhere. Even the standard library function will not be found because its name is `sqrt` as

always.

Another imagined problem was that a call

```
f(x);
```

would suddenly change its meaning when a function became overloaded by the inclusion of a new header file containing the declaration of another function `f()`. This is not the case, because the C++ ambiguity rules ensure that the introduction of a new `f()` will either leave the meaning of `f(x)` unchanged (the new `f()` was unrelated to the type of `x`) or will cause a compile time error because an ambiguity was introduced.

## C Linkage

This leaves the problem of how to call a C function or a C++ function “masquerading” as a C function. To do this a programmer must state that a function has C linkage. Otherwise, a function is assumed to be a C++ function and its name is encoded. To express this an extension of the “extern” declaration is introduced into C++:

```
extern "C" {
    double sqrt(double);           // sqrt(double) has C linkage
}
```

This linkage specification does not affect the semantics of the program using `sqrt()` but simply tells the compiler to use the C naming conventions for the name used for `sqrt()` in the object code. This means that the name of *this* `sqrt()` is `sqrt` or `_sqrt` or whatever is required by the C linkage conventions on a given system. One could even imagine a system where the C linkage rules were the type-safe C++ linkage rules as described above so that the name of `sqrt()` was `sqrt__Fd`. Linkage specifications nest, so that if we had other linkage conventions such as Pascal linkage we could write:

```
extern "C" {
    // default: C++ linkage here
    extern "Pascal" {
        // C linkage here
        extern "C++" {
            // Pascal linkage here
            // C++ linkage here
        }
        // Pascal linkage here
    }
    // C linkage here
}
// C++ linkage here
```

Such nestings will typically only occur as the result of nested `#includes`.

The `{}` in a linkage specification does *not* introduce a new scope; the braces are simply used for grouping. This strongly resembles the use of `{}` in enumerations.

The keyword `extern` was used because it is already used to specify linkage in C and C++. Strings (for example, "C" and "C++") were chosen as linkage specifiers because identifiers (e.g., C and Cplusplus) would de facto introduce new keywords into the language and because a larger alphabet can be used in strings.

Naturally, only one of a set of overloaded functions can have C linkage, so the following causes a compile time error:

```
extern "C" {
    double sqrt(double);
    complex sqrt(complex);
}
```

Note that C linkage can be used for C++ functions intended to be called from C programs as well as for C functions. In particular, it is necessary to use C linkage for C++ functions written to implement standard C library functions for use by C programs. However, using the encoded C++ name from C preserves type-safety at link time. This technique can be valuable in other languages too. I have already seen an example of the C++ scheme applied to assembly code to prevent nasty link errors for low level routines. One might consider using this C++ linkage scheme for C also, but I suspect that the sloppy use of type information in many C programs would make that too painful.

In an "all C++" environment no linkage specifications would be needed. The linkage mechanism is intended to ease integration of C++ code into a multi-lingual system.

### Caveat

One could extend this linkage specification mechanism to other languages such as Fortran, Lisp, Pascal, PL/1, etc. The way such an extension is done should be considered very carefully because one "obvious" way of doing it would be to build into a C++ compiler the full knowledge of the type structure and calling conventions of such "foreign" languages. For example, a C++ compiler *might* handle conversion of zero terminated C++ strings into Pascal strings with a length prefix at the call point of function with Pascal linkage and *might* use Fortran call by reference rules when calling a function with Fortran linkage, etc.

There are serious problems with this approach:

- The complexity and speed of a C++ compiler could be seriously affected by such extensions.
- Unless an extension is widely available, accepted programs using it will not be portable.
- Two implementations might "extend" C++ with a linkage specification to the same "foreign" language, say Fortran, in different ways so as to make identical C++ programs have subtly different effects on different implementations.

Naturally, these problems are not unique to linkage issues or to this approach to linkage specification.

I conjecture that in most cases linkage from C++ to another language is best done simply by using a common and fairly simple convention such as "C linkage" plus some standard library routines and/or rules for argument passing, format conversion, etc., to avoid building knowledge of non-standard calling conventions into C++ compilers. This ought to be simpler from C++ than from most other languages. For example, reference type arguments can be used to handle Fortran argument passing conventions in many cases and a Pascal string type with a constructor taking a C style string can trivially be written. Where extensions are unavoidable, however, C++ now provides a standard syntax for expressing them.

## Experience

The natural first reaction to this scheme is to look for a way of handling linkage and overloading without requiring explicit linkage specifications. We have not been able to come up with a system that enabled C linkage to be implicit without serious side effects. I will summarize the advantages of the adopted scheme here and discuss several possible objections to it. "Alternative Solutions" below describes alternative schemes that were considered and rejected.

### Making Linkage Specifications Invisible

One obvious advantage of this scheme is that it allows a programmer to give a set of functions C linkage with a single linkage specification without modifying the individual function declarations. This is particularly useful when standard C headers are used. Given a C header (that is, an ANSI C header with function prototypes, etc.)

```
// C header:  
// C declarations
```

one can trivially modify the header for use from C++:

```
// C++ header:  
  
extern "C" {  
    // C header:  
    // C declarations  
}
```

This creates a C++ header that cannot be shared with C.

Sharing with C can be achieved using `#ifdef`:

```
// C and C++ header:  
  
#ifdef __cplusplus  
extern "C" {  
#endif  
    // C header:  
    // C declarations  
#ifdef __cplusplus  
}  
#endif
```

where `__cplusplus` is defined by every C++ compiler.

In cases where one for some reason cannot or should not modify the header itself one can use an indirection:

```
// C++ header:

extern "C" {
#include "C_header"
}
```

Fortunately, such transformations can be done by trivial programs so that most of the effort in converting C headers need not be done by hand.

It was soon discovered that even though programmers tend to scatter function declarations throughout the C++ program text, most C functions actually come from well defined C libraries for which there are — or ought to be — standard header files.

Placing all of the necessary linkage specifications in standard header files means that they are not seen by most users most of the time. Except for programmers studying the details of C library interfaces, programmers installing headers for new C libraries for C++ users, and programmers providing C++ implementations for C interfaces, the linkage specifications are invisible.

## Error Handling

The linker detects errors, but reports them using the names found in the object code. This can be compensated for by adding knowledge about the C++ naming conventions to the linker or (simpler) by providing a filter for processing linker error messages. This output was produced by such a filter:

C++ symbol mapping:

PathListHead::~PathListHead()	__dt__12PathListHeadFv
Path_list::sepWork()	sepWork__9Path_listFv
Path::pathnorm()	pathnorm__4PathFv
Path::operator&(Path&)	__ad__4PathFR4Path
Path::first()	first__4PathFv
Path::last()	last__4PathFv
Path::rfirst()	rfirst__4PathFv
Path::rmlast()	rmlast__4PathFv
Path::rmdots()	rmdots__4PathFv
Path::findpath(String&)	findpath__4PathFR6String
Path::fullpath()	fullpath__4PathFv

Bringing this filter into use had the curious effect of replacing the usual complaint about “ugly C++ names” with complaints that the linker didn’t provide sufficient information about C functions and global data objects.

The reason for presenting the encoded and unencoded names of undefined functions side by side is to help users who use tools, such as debuggers, that haven’t yet been converted to understand C++ names.

A plain C debugger such as `sdb`, `dbx`, or `codeview` can be used for C++ and will correctly refer to the C++ source, but it will use the encoded names found in the object code. This can be avoided by employing a routine that “reverses” the encoding, that is, reads an encoded name and extracts information from it.<sup>1</sup> The encoding scheme is described under “The Function Name Encoding Scheme.” A standard C++ name decoder should be generally available for use by debugger writers and others who deal directly with object code. Until such decoders are in widespread use the programmer must have at least a minimal understanding of the encoding scheme.

## Upgrading Existing C++ Programs

Decorating the standard header files with the appropriate linkage specifications had two effects. The first phenomenon observed was that most of the declarations scattered in the program text that were referring to C functions were either redundant (because the function had already been declared in a header) or at least potentially incorrect (because they differed from the declaration of that header file on some commonly used system). The second phenomenon observed was that every non-trivial program converted to the new linkage system contained inconsistent function declarations. A noticeable number of declarations found in the program text were plain wrong, that is, different from the ones used in the function definition. This was caused in part by sloppiness, for example, where a programmer had declared a function

```
f(int ...);
```

to shut up the compiler instead of looking up the type of the second argument. A more common problem was that the "standard" header files had changed since the function declaration was placed in the text so that the "local" declaration didn't match any more; this often happens when a file is transferred from one system to another, say from a BSD to a System V.

In summary, introducing the new linkage system involved adding linkage specifications. Typically, these linkage specifications were only needed in standard header files. The process of introducing linkage specifications invariably revealed errors in the programs — even in programs that had been considered correct for years. The process strongly resembles trying `lint` on an old C program.

As was expected, some programmers first tried to get around the requirements for explicit C linkage by enclosing their entire program in a linkage directive. This might have been considered a fine way of converting old C++ programs with minimum effort had it not had the effect of ensuring that every program that uses facilities provided by such a program would also have to use the unsafe C linkage. To achieve the benefits from the new linkage scheme most C++ programs must use it. The requirement that at most one of a set of overloaded functions can have C linkage defeats this way of converting programs. The slightly slower and more involved method of using standard header files (already containing the necessary linkage specifications) and adding a few extra linkage specifications in local headers where needed must be used. This also has the benefit of unearthing unexpected errors.

## Details

The scope of C function declarations has always been a subject for debate. In the context of C++ with linkage specifications and overloaded functions it seems prudent to answer some variations of the standard questions.

### Default Linkage

Consider:

```
extern "C" {
    int f(int);
}

int f(int);    // default: f() has C++ linkage
```

Is it the same `f()` that was defined with C linkage above and does it have C or C++ linkage? It is the same `f()` and it does (still) have C linkage. The first linkage specification “wins” provided the second declaration has “only” default (that is, C++) linkage.

Where linkage is explicitly specified for a function, that specification must agree with any previous linkage. For example:

```
extern "C" {
    int f(int);    // f() has C linkage
}

int g();          // default: g() has C++ linkage

extern "C++" {
    int f(int);    // error: inconsistent linkage specification
    int g();       // fine
}
```

The reason to require agreement of explicit linkage specifications is to avoid unnecessary order dependencies. The reason to allow a second declaration with implicit C++ linkage to take on the linkage from a previous explicit linkage specification is to cope with the common case where a declaration occurs both in a `.c` file and in a standard header file.

## Declarations in Different Scopes

Consider:

```
extern "C" {
    int f(int);
}

void g1()
{
    int f(int);
    f(1);
}
```

Is the `f()` declared local to `g1` the same as the global `f()` and does the function called in `g1()` have C linkage? It is the same `f()` and it does have C linkage.

Consider:

```
extern "C" {
    int f(int);
}

void g2()
{
    int f(char*);
    f(1);
    f("asdf");
}
```

Does the local declaration of `f()` overload the global `f()` or does it hide it? In other words, is the call `f(1)` legal? That call is an error because the local declaration introduces a new `f()`. In the tradition of C, the declaration of `f(char*)` also draws a warning.

Consider:

```
void g3()
{
    int ff(int);
};

void g4()
{
    int ff(char*);
    ff("asdf");
    ff(1);
};
```

Does the second declaration of `ff()` overload the first? In other words, is the call `ff(1)` legal? The call is an error and a warning is issued about the two declarations of `ff()` because (as in the example above) overloading in different scopes is considered a likely mistake.

### Local Linkage Specification

Linkage specifications are *not* allowed inside function definitions. For example:

```
void g5()
{
    extern "C" {          // error: linkage specification in function
        int h();
    }
}
```

The reason for this restriction is to discourage the use of local declarations of C functions and to simplify the language rules.



## Alternative Solutions

So, the linkage specification scheme works, but isn't there a better way of achieving the benefits of that scheme? Several schemes were considered. This section presents the first two or three alternatives people usually come up with and explains why we rejected them. Naturally, we also considered more and weirder solutions, but all the plausible ones were variations of the ones presented here.

### The Scope Trick

The first attempt to provide type-safe linkage involved the use of **overload** and the C++ scope rules. All overloaded function names were encoded, but non-overloaded function names were not. This scheme had the benefit that the linkage rules for most functions were the C linkage rules — and had the problem that those rules are unsafe. The most obvious problem was that at first glance there is no way of linking an overloaded function to a standard C library function. This problem was handled using a “scope trick”:

```

overload sqrt;
complex sqrt (complex);
inline double sqrt (double d)
{
    extern double sqrt (double);    // A completely new sqrt ()
                                    // not overloaded

    return sqrt (d);                // not a recursive call
                                    // but a call of the C function
                                    // sqrt
}

```

In effect, we provided a C++ calling stub for the C function `sqrt()`. The snag is that having thus *defined* `sqrt(double)` in a standard header a user cannot provide an alternative to the standard version. The problems with library combination in the presence of **overload** are not addressed in this scheme, and are actually made worse by the proliferation of definitions of overloaded functions in header files. In particular, if two “standard” libraries each overload a function then these two libraries cannot be used together since that function will be defined twice: once in each of the two standard headers.

There is also a compile time overhead involved. In retrospect, I consider this scheme somewhat worse than the original “the first overloaded has C linkage” scheme.

### C “Storage Class”

It is clear that the definitions providing a calling stub are redundant. We could simply provide a way of stating that a member of a set of overloaded functions should be a C function. For example:

```

complex sqrt (complex);
cdecl double sqrt (double);    // sqrt (double) has C linkage

```

This is equivalent to

```

complex sqrt (complex);
extern "C" {
    double sqrt (double);
}

```

but less ugly. However, it involves complicating the C++ language with yet another keyword. Functions from other languages will have to be called too and they each have separate requirements for linkage so the logical development of this idea would eventually make *ada*, *fortran*, *lisp*, *pascal*, etc., keywords. Using a keyword also requires modification of the declarations of the C functions and those are exactly the declarations we would want *not* to touch since they will typically live in header files shared with an ANSI C compiler. In some cases we would even like not to touch a file in which such declarations reside.

### Overload "Storage Class"

The use of a keyword to indicate that a function is a C function is logically very similar to the linkage specification solution, though inferior in detail. An alternative is to have a keyword indicate that a function should have its signature added. The keyword *overload* might be used. For example:

```

overload complex sqrt (complex); // use C++ linkage
double sqrt (double);           // C linkage by default

```

This has the disadvantage that the programmer has to add information to gain type safety rather than having it as default and would de facto ensure that the C++ type-safe linkage rules would only be used for overloaded functions. Furthermore, this would mean that libraries could only be combined if the designers of these libraries had decorated all the relevant functions with *overload*. This scheme also invalidates all old C++ programs without providing significant benefits.

### Calling Stubs

One way of dealing with C linkage would be *not* to provide any facilities for it in the C++ language, but to require every function called to be a C++ function. To achieve this one would simply re-compile all libraries and have one version for C and another for C++. This is a lot of work, a lot of waste, and not feasible in general. In the cases where recompilation of a C program as a C++ program is not a reasonable proposition (because you don't have the source, because you cannot get the program to compile, because you don't have the time, because you don't have the file space to hold the result, etc.) you can provide a small dummy C++ function to call the C function. Such a function would be written in C (for portability) or in assembler (for efficiency). For example:

```

double sqrt__Fd(d) double d; /* C calling stub for sqrt(double): */
{
    extern double sqrt ();
    return sqrt (d);
}

```

A program can be provided to read the linker output and produce the required stubs.

This scheme has the advantage that the user works in what appears to be an "all C++" environment (but so does the adopted scheme once a few C libraries have been recompiled with C++ and/or a few header files have been decorated with linkage specifications). It does, however, also suffer from a few severe disadvantages. A "C calling stub maker" program cannot be written portably. Therefore, it would become a bottleneck for porting C++ implementations and C++ programs and thus a bottleneck for the use of C++. It is also not clear that this approach can be implemented everywhere without loss

of efficiency since it requires large numbers of functions to have two names (a C name and a C++ name). This takes up code space and introduces large numbers of extra names that would slow down programs reading object files such as linkers, loaders, debuggers, etc. The C calling interfaces would also be ubiquitous and available for anyone to use by mistake, thus re-introducing the C linkage problems in a new guise.

## Encode Only C++ Functions

The fundamental problem with all but the last scheme outlined above is that they require the programmer to decorate the source code with directives to help the compiler determine which functions are C functions. Ideally, the compiler would simply look at the program and determine the linkage necessary for each individual function based on its type. Could the compiler be that smart? Unfortunately, no. There is no way for the compiler to know whether

```
extern double sqrt(double);
```

is written in C or C++. However, one might handle most cases by the heuristic that if a function is clearly a C++ function it gets C++ linkage and if it isn't it gets C linkage. For example:

```
complex sqrt(complex);           // clearly C++: sqrt__F7complex
double sqrt(double);            // could be C:sqrt
```

Since `complex` is a class, `sqrt(complex)` is clearly a C++ function and it is encoded. The other `sqrt()` might be C so it isn't.

Applying this heuristic would mean that most functions would not have type-safe linkage — but we are used to that. It would also mean that overloading a function based on two C types would be impossible or require special syntax:

```
int max(int,int);
double max(double,double);
```

Such overloading *must* be possible because there are many such examples and several of those are important, especially when support for both single and double precision floating point arithmetic becomes widespread:

```
float sqrt(float);
double sqrt(double);
```

This implies that either `overload` or linkage specifications must be introduced to handle such cases. The heuristic nature of the specification of where these directives are needed will lead to confusion, overuse, and errors.

If `overload` is re-introduced, the cautious programmer will use it systematically wherever a relatively simple class is used (in case a revision of the system should turn it into a plain C struct), wherever an argument is typedef'd (because that typedef might some day refer to a plain C type), and wherever there is any doubt. This will lead to the now well known problems of combining libraries. Similarly, if linkage specifications are required anywhere, they will proliferate because of doubts about where they are needed.

It does not seem wise to refrain from checking linkage in a large number of cases and to introduce a rather arbitrary heuristic into the linking rules for C++ without being able to reduce the complexity of the language or to reduce the burden on the programmer somewhere.

### Nothing

Naturally, while considering these alternative schemes the easy option of doing nothing was regularly re-considered. However, the original scheme still suffers from the problems described in section 3: insecure linkage, spurious **overload** declarations, and overloading rules that complicate the life of library writers and library users.

## Syntax Alternatives

The scheme of giving all C++ functions type-safe linkage and providing a syntax for expressing that a given function is to have C linkage was thus chosen and tried. However, there were still several alternatives for expressing C linkage for this general scheme.

### Why **extern**?

Instead of employing the existing keyword **extern** we might have introduced a new one such as **linkage** or **foreign**. The introduction of a new keyword always breaks some programs (though usually not in any serious way and for a well chosen new keyword not many programs) and **extern** already has the right meaning in C and C++. In almost all cases **extern** is redundant since external linkage is the default for global names and for locally declared functions. When used, **extern** simply emphasizes the fact that a name should have external linkage. The use of **extern** introduced here merely allows the programmer to tag an **extern** declaration with information of *how* that linkage is to be established.

### Linkage for Individual Functions

One obvious alternative is to add the linkage specification to each individual function:

```
extern "C" double sqrt(double); // sqrt(double) has C linkage
```

The problem with this is that it does not serve the need to be able to give a set of C functions C linkage with one declaration and requires the declaration of every C function to be modified. In particular, it does not allow a C header (that is, an ANSI C header) to be used from a C++ program in such a way that all the functions declared in it get C linkage.

This notation for linkage specification of individual functions is not just an alternative to the linkage "block" adopted but also an obvious extension to the adopted syntax. I intend to review the situation after the current scheme has been used a while longer to see if the use of linkage specifications warrants this extension.

### Linkage Pragmas

The original implementation of the linkage specifications used a **#pragma** syntax:

```
#pragma linkage C
double sqrt(double);    // sqrt(double) has C linkage
#pragma linkage
```

This was considered too ugly by many but did appear to have significant advantages. For example, it can be argued that linkage to “foreign languages” is not part of the language proper. Such linkage cannot be specified once and for all in a language manual since it involves the *implementations of two* languages on a given system. Such implementation specific concepts are exactly what pragmas were introduced into Ada and ANSI C to handle. The `#pragma` syntax was trivial to implement and easy to read. It was also ugly enough to discourage overuse and to encourage hiding of linkage specifications in header files.

There are problems with this view, though. For example, it is most often assumed that any `#pragma` can be ignored without affecting the meaning of a program. This would not be the case with linkage pragmas. Another problem is that for the moment many C implementations do not support a pragma mechanism and it is not certain that those that do can be relied upon to “do the right thing” for linkage pragmas used by a C++ compiler.

Linkage to a particular foreign language does not belong in C++ because such linkage will in principle be local to a given system and non-portable. However, the fact that linkage to other languages occurs is a general concept that can and ought to be supported by a language intended to be used in multi-language environments. In practice, one can assume that at least C and Fortran will be available on most systems where C++ is used and that a large group of users will need to call functions written in these languages. Consequently, one would expect C++ implementations to support C and Fortran linkage.

The fact that C (like most other languages) does not provide a concept of linkage to program fragments written in other languages led to the absence of an explicit linkage mechanism in C++ and to the problems of link safety and overloading.

### Special Linkage Blocks

Another approach would be to introduce a new keyword, say `linkage`, and use it to specify both the start and the end of a linkage block:

```
linkage("C");
double sqrt(double);    // sqrt(double) has C linkage
linkage("");
```

This avoids introducing yet another meaning for `{}`, allows setting and restoring of linkage to be two separate operations, allows all linkage directives to be found by simple pattern matching in a line oriented editor, and allows all linkage directives to be suppressed by a single macro

```
#define linkage(a)
```

The problem with this seems to be that it tempts people to think of linkage as a compiler “mode” that can be switched on and off at random times and doesn’t obey block structure. For example:

```
linkage("C");

double sqrt(double);           // sqrt(double) has C linkage

f() {
    extern g();                // g() has C linkage
    linkage("");
    extern h();                // h() has C++ linkage
    ...
}
```

It also becomes hard to convince people that linkage specifications come in pairs and can be nested.

The same approach, with the same educational problems, can be tried without introducing a new keyword:

```
extern "C";
double sqrt(double);          // sqrt(double) has C linkage
extern "";
```

Note that whatever syntax was chosen, linkage specifications were intended to obey block structure to fit cleanly into the language. In particular, if linkage "blocks" and ordinary blocks were not obliged to nest the job of writers of tools manipulating C++ source text, such as a C++ incremental compilation environment, would be needlessly complicated.

## Conclusions

The use of function name encodings involving type signatures provides a significant improvement in link safety compared to C and earlier C++ implementations. It enables the (eventual) abolition of the redundant keyword **extern** and allows libraries to be combined more freely than before. The use of linkage specifications enables relatively painless linkage to C and eventually to other languages as well. The scheme described here appears to be better than any alternative we have been able to devise.

## The Function Name Encoding Scheme

The (revised) C++ function name encoding scheme was originally designed primarily to allow the function and class names to be reliably extracted from encoded class member names. It was then modified for use for *all* C++ functions and to ensure that relatively short encodings (less than 31 characters) could be achieved reliably for systems with limitations on the length of identifiers seen by the linker. The description here is just intended to give an idea of the technique used, not as a guide for implementors.

The basic approach is to append a function's signature to the function name. The separator `__` is used so a decoder could be confused by a name that contained `__` except as an initial sequence, so don't use names such as `a__b__c` in a C++ program if you like your debugger and other tools to be able to decompose the generated names.

The encoding scheme is designed so that it is easy to determine

- if a name is an encoded name
- what (unencoded) name the user wrote
- what class (if any) the function is a member of
- what are the types of the function arguments

The basic types are encoded as

void	v
char	c
short	s
int	i
long	l
float	f
double	d
long double	r
...	e

A global function name is encoded by appending `__F` followed by the signature so that `f(int,char,double)` becomes `f__Ficd`. Since `f()` is equivalent to `f(void)` it becomes `f__Fv`.

Names of classes are encoded as the length of the name followed by the name itself to avoid terminators. For example, `x::f()` becomes `f__1xFv` and `rec::update(int)` becomes `update__3recFi`.

Type modifiers are encoded as

unsigned	U
const	C
volatile	V
signed	S

so `f(unsigned)` becomes `f__FUi`. If more than one modifier is used they will appear in alphabetical order so `f(const signed char)` becomes `f__FCSc`.

The standard modifiers are encoded as

pointer *	P
reference	&R
array	[10]A10_
function ()	F
ptr to member	S:*M1S

So `f(char*)` becomes `f__FPc` and `printf(const char* ...)` becomes `printf__FPCce`.

To shorten encodings repeated types in an argument list are not repeated in full; rather, a reference to the first occurrence of the type in the argument list is used. For example:

```
f(complex, complex);           // f_F7complexT1
                                // the second argument is of the same
                                // type as argument 1

f(record, record, record, record); // f_F6recordN31
                                // the 3 arguments 2, 3, and 4 are of
                                // the same type as argument 1
```

A slightly different encoding is used on systems without case distinction in linker names. On systems where the linker imposes a restriction on the length of identifiers, the last two characters in the longest legal name are replaced with a hash code for the remaining characters. For example, if a 45 character name is generated on a system with a 31 character limit, the last 16 characters are replaced by a 2 character hash code yielding a 31 character name.

Naturally, the encoding of signatures into identifier of limited length cannot be perfect since information is destroyed. However, experience shows that even truncation at 31 characters for the old and less dense encoding was sufficient to generate distinct names in real programs. Furthermore, one can often rely on the linker to detect accidental name clashes caused by the hash coding. The chance of an undetected error is orders of magnitude less than the occurrence of known problems such as C programmers accidentally choosing identical names for different objects in such a way that the problem isn't detected by the compiler or the linker.



---

## Footnotes

1. Naturally, this would be the same function as was used to write the linker output filter. The examples here are based on the name decoding routine written by Steve Brandt and used to modify the UNIX System V C debugger `sdb` into `sdb++`.



---

# 7 Access Rules for C++

---

---

<b>Access Rules for C++</b>	7-1
Introduction	7-1
Access Rules	7-1
Explanation	7-2
Base Member Declarations	7-5
Examples (Not Interdependent)	7-6

---

<b>Footnotes</b>	7-12
------------------	------

---



---

# Access Rules for C++

**NOTE**

This chapter is taken directly from a paper by Phil Brown.

## Introduction

One feature of C++ is the provision for function and data protection through a combination of the following:

- **public, protected, and private class members**

Every class member has an associated level of protection. **public** indicates no protection, whereas **private** indicates access is limited to members and friends. **protected** is similar to **private** except that it allows access additionally to derived classes.

- **inheritance**

Derived classes are defined in terms of base classes. Inheritance is the name and description of this process, by which a derived class acquires the data and functions of its base classes. As previously noted, the **private** members of the base classes are not accessible in the derived class. The protection of other members is dependent on the type of the derivation. **public** and **protected** members of **public** base classes will have the same protection in the derived class. These same members from a **private** base class will be **private** in the derived class. (See Figure 7-1)

- **friendship**

Friendship overrides all protections within a class. A friend declaration within a class denotes another class<sup>1</sup> or function as a *potential* friend.

The following access rules define when a *potential* friend will be considered a friend.

This paper defines the C++ access rules, as they relate to the various protection methods, and explains some of the reasoning for these rules.

## Access Rules

1. Any visible non-“class member” is accessible.
2. If an object is accessible, then
  - a. **public** members of the object’s class type are accessible.
  - b. *potential* friends of the object’s class type will be considered friends.
  - c. The same level of access applies to the **public** base classes of the object’s class type.

3. All members of a class, and **public** and **protected** members of its base classes, are accessible by member and friend functions of the class.<sup>2</sup>

## Explanation

1. *Any visible non-“class member” is accessible.*

The first of the access rules is the starting point for many references. In the following:

```
int i;

void
f() {
    i = 1;    // OK - Rule #1
}
```

the variable `i` is accessible since it is not a class member and is visible in the function `f`.

2. *If an object is accessible, then*

- a. *public members of the object's class type are accessible.*

The first part of the second rule is a restatement of its condition. Access to **public** members of a class object is the minimal amount of accessibility (excluding *no access*).

```
class B {
public:
    int i;
};

void
f() {
    B b;
    b.i = 1;    // OK - Rule #1, #2a
}
```

In this case, the variable `b` is accessible by Rule #1. Since `b` is accessible, the public member `i` of class `B` will be accessible (Rule #2a).

- b. *potential friends of the object's class type will be considered friends.*

One way to view this is to consider a friend declaration as a **public** member which will not be honored unless that friend declaration is accessible. Once friendship *has* been established, access is described by Rule #3.

```

class B {
private:           // unnecessary
    int i;
    friend void f();
};

class D : private B {
};

void
f() {
    B b;
    b.i = 1; // OK - Rule #1, #2b, #3
    D d;
    d.i = 1; // ERROR - Rule #1, #2a, -fail-
}

```

In this example, both variables **b** and **d** are accessible according to Rule #1. However, in the first case, the function **f** is a friend of class **B** since, by Rule #2b, **b** is accessible and class **B** has a friend declaration for the function **f**. Rule #3 states that, as a friend, **f** will have access to all of the members of class **B**. The assignment to **b.i** is thus valid. In the second case, the public members of **d** are accessible according to Rule #2a. Since function **f** is not a friend of class **D**, and class **B** is not a public base class of class **D**, there are no other access rules to apply. The assignment to **d.i** is invalid.

- c. *the same level of access applies to the public base classes of the object's class type.*

This rule applies when Rule #3 cannot (access is not by a member or friend). Notice that there will be *no access* to private base classes.

```

class B {
public:
    int i;
};

class D : public B {
private:           // unnecessary
    int j;
};

void
f() {
    D d;
    d.i = 1;           // OK - Rule #1, #2a, #2c
    d.j = 1;          // ERROR - Rule #1, #2a, -fail-
}

```

In this example, the variable **d** is accessible according to Rule #1. According to Rule #2a, the public members of class **D** are thus accessible. Since **j** is a private member of class **D**, it will not be accessible. However, by Rule #2c, since class **B** is a public base class of class **D**, the public members of class **B** will also be accessible. The assignment to **d.i** is valid.

3. *All members of a class, and **public and protected** members of its base classes, are accessible by member and friend functions of the class. (self-explanatory)*

The reasoning for the rules as they apply to inheritance is illustrated by Figure 7-1.

Figure 7-1: Derivation Relationship

---

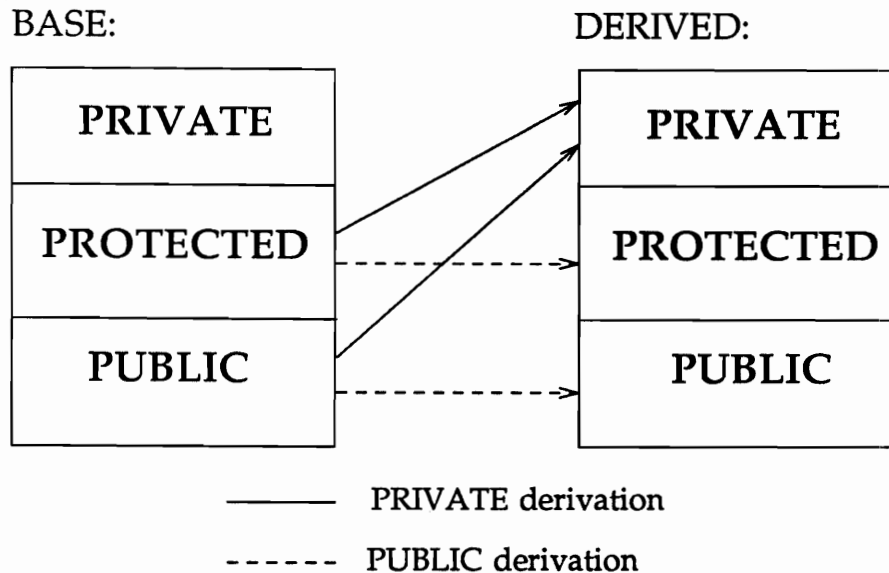

This diagram shows the level of protection of a base class member when referenced through a derived class. As indicated in Rule #3, since friends and members of the derived class have access to all members of the derived class, they will also have access to the **public and protected** members of any base class.

When neither a friend nor member of the derived class, access to base class members will be determined by the type of derivation. If it is a **private** derivation, the base class members will be **private** in the derived class. As such, the base class members will not be accessible. However, in a **public** derivation, the same level of access will apply for base class members as applies within the derived class.



## Base Member Declarations

**public** and **protected** base member declarations in a derived class (of the form `base_class::member`) can be used to alter the accessibility of class members. When given in a **private** derived class, a base member declaration will make the designated base member appear to be a member of the derived class.<sup>3</sup> Thus, accessibility of the member will be determined at the level of the derived class.

A superfluous base member declaration (i.e., one given in a **public** derived class) is ignored. This is necessary since an inaccessible base member declaration can conceivably hide a validly accessible base member.

```
class A {
protected:
    int i;
    friend f();
};

class B : public A {
protected:
    A::i;
};

void f() {
    B* p;
    p->i = 1;           // This would be illegal if the base
                       // member declaration was not ignored
}
```

## Examples (Not Interdependent)

```
//----- start of example 01 -----

class B {
    int i;
    friend void f();
};

class D : public B {
};

void
f() {
    B* p = new B;
    D* q = new D;

    int fi1 = p->i;          // OK - Rule #1, #2b, #3
    int fi2 = q->i;          // OK - Rule #1, #2a, #2c, #2b, #3
}

//----- start of example 02 -----

class B {
    int i;
};

class D : public B {
};

void
f() {
    B* p = new B;
    D* q = new D;

    int fi1 = p->i;          // ERROR - Rule #1, #2a, -fail-
    int fi2 = q->i;          // ERROR - Rule #1, #2a, #2c, -fail-
}

//----- start of example 03 -----

class B {
    int i;
    friend C;
};

class C : private B {
    friend D;
    void f1() {
        int fi1 = i;          // OK - Rule #3, #2b, #3
    }
}
```

```
};

class D : public C {
    void f2() {
        int fi2 = i;          // ERROR - Rule #3, #2b, #3, -fail-
    }
};

//----- start of example 04 -----

class B {
    int i;
    friend D;
};

class C : private B {
};

class D : public C {
    void f() {
        int fil = i;        // ERROR - Rule #3, -fail-
    }
};

//----- start of example 05 -----

class B {
    int i;
    friend D;
};

class C : public B {
};

class D : private C {
    void f() {
        int fil = i;        // OK - Rule #3, #2c, #2b, #3
    }
};

//----- start of example 06 -----

class B {
    int i;
    friend D;
};

class D {
    void f() {
        B* p = new B;
        int fil = p->i;     // OK - Rule #1, #2b, #3
    }
};
```

```
};

//----- start of example 07 -----

class B {
protected:
    int a;
};

class D : public B {
    friend void f();
public:
    int b;
};

void
f() {
    D* p;
    p->a = 1;           // OK - Rule #1, #2b, #3
    p->b = 2;           // OK - Rule #1, #2a

    B* pp;
    pp->a = 1;          // ERROR - Rule #1, #2a, -fail-
    pp->b = 1;          // ERROR - Rule #1, #2a, -fail-

    pp = p;
    pp->a = 1;          // ERROR - Rule #1, #2a, -fail-
    pp->b = 2;          // ERROR - Rule #1, #2a, -fail-
}

//----- start of example 08 -----

class A {
protected:
    int a;
};

class B : public A {
};

class C : public B {
    void f(B* p);
};

void
C::f(B* p) {
    a = 1;             // OK - Rule #3, #2c
    p->a = 2;           // ERROR - Rule #1, #2a, #2c, -fail-
}

//----- start of example 09 -----
```

```

class A {
    int a;
    friend void f();
};

class B : public A {
};

void
f() {
    B* p;
    p->a = 1;           // OK - Rule #1, #2a, #2c, #2b, #3

    A* p2;
    p2->a = 2;        // OK - Rule #1, #2b, #3
}

//----- start of example 10 -----

class B {
    friend void f1();
public:
    int a;
};

class C : private B {
    friend void f2();
};

class D : public C {
};

void
f1() {
    D* p1;
    p1->a = 1;        // ERROR - Rule #1, #2a, #2c, -fail-
}

void
f2() {
    D* p2;
    p2->a = 1;        // OK - Rule #1, #2a, #2c, #2b, #3
}

//----- start of example 11 -----

class B {
    friend void f1();
    int a;
};

class C : private B {

```

```
        friend void f2();
};

class D : public C {
};

void
f1() {
    D* p1;
    p1->a = 1;           // ERROR - Rule #1, #2a, #2c, -fail-
}

void
f2() {
    D* p2;
    p2->a = 1;           // ERROR - Rule #1, #2a, #2c, #2b, #3, -fail-
}

//----- start of example 12 -----

class B {
    friend void f1();
public:
    int a;
};

class C : public B {
    friend void f2();
};

class D : public C {
};

void
f1() {
    D* p1;
    p1->a = 1;           // OK - Rule #1, #2a, #2c, #2c
}

void
f2() {
    D* p2;
    p2->a = 1;           // OK - Rule #1, #2a, #2c, #2b, #3
}

//----- start of example 13 -----

class B {
    friend void f1();
    int a;
};
```

```
class C : public B {
    friend void f2();
};

class D : public C {
};

void
f1() {
    D* p1;
    p1->a = 1;           // OK - Rule #1, #2a, #2c, #2c, #2b, #3
}

void
f2() {
    D* p2;
    p2->a = 1;           // ERROR - Rule #1, #2a, #2c, #2b, #3, -fail-
}

//-----
```

---

## Footnotes

1. Denoting a class as a friend, in effect, denotes each function member of that class as a friend.
2. Rules #2b and #3 can be combined to override Rule #2c.
3. A **public** base member declaration must appear in a **public** section of the derived class. Similar logic applies to the **protected** case.



---

# **A** Appendix A

---

**Manual Pages for C++ Language System**

A-1

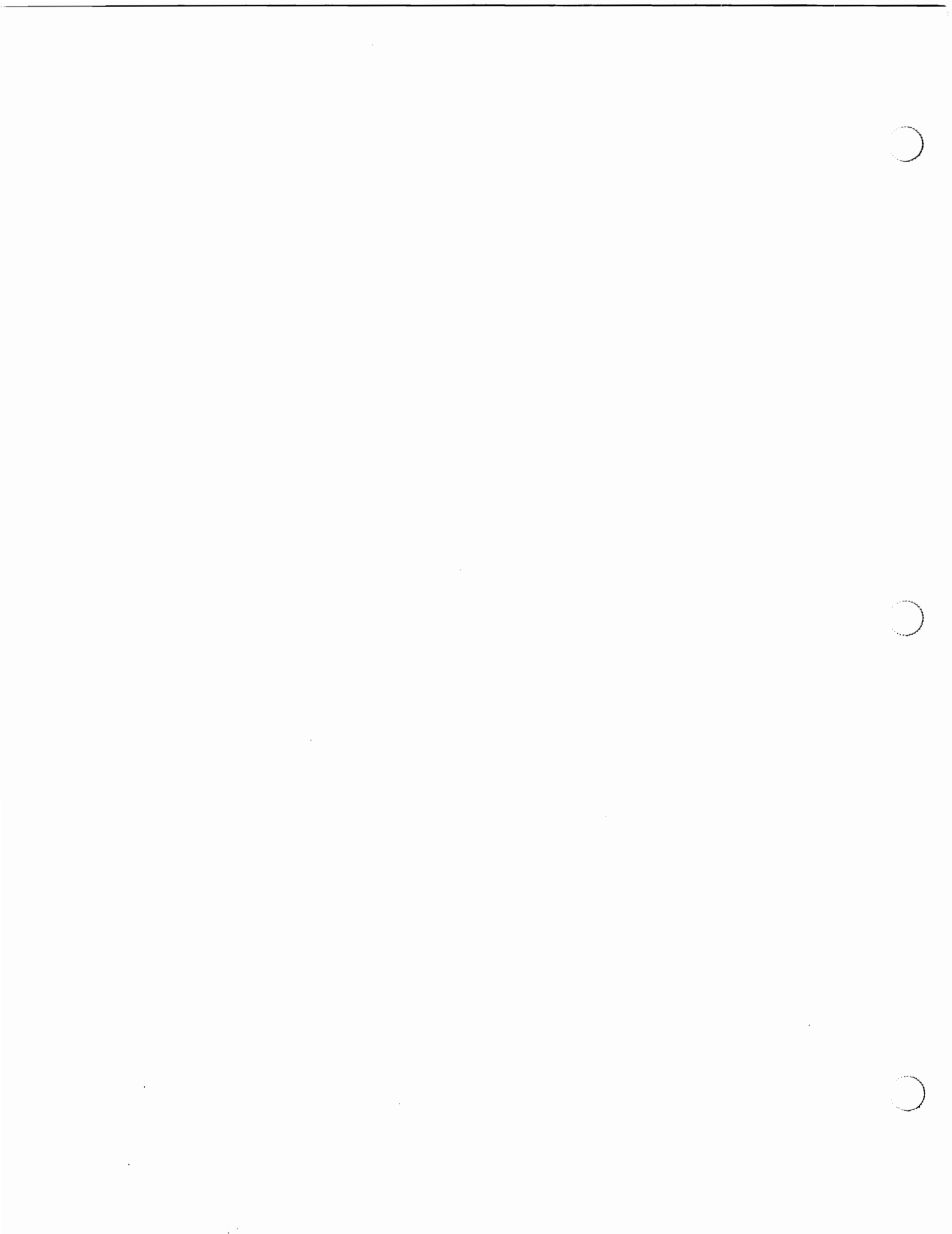

## NAME

CC - C++ translator

## SYNOPSIS

CC [-E] [-F|-Fc] [-*suffix*] [+i] [+L] [+x *file*] [+e0|+e1] [+d] [+w] [+p] [+a0|+a1] *file* ...

## DESCRIPTION

CC (capital CC) translates C++ source code to C source code. The command uses *cpp*(1) for preprocessing, *cfront* for syntax and type checking, and *cc*(1) for code generation.

For each C++ source file, CC creates a temporary file in */usr/tmp*, *file.c*, containing the generated C file for compilation with *cc*. The *+i* or *-.suffix* options will save a copy of this file in the current directory, with the name *file..c* or *file.suffix*.

CC takes arguments ending in *.c*, *.C* or *.i* to be C++ source programs. *.i* files are presumed to be the output of *cpp*(1). Both *.s* and *.o* files are also accepted by the CC command and passed to *cc*(1).

CC interprets the following options:

- E Run only *cpp* on the C++ source files and send the result to standard output.
- F Run only *cpp* and *cfront* on the C++ source files, and send the result to standard output.
- Fc Like the -F option, but the output is C source code suitable as a *.c* file for *cc*(1).
- suffix* Instead of using standard output for the -E, -F or -Fc options, place the output from each *.c* file on a file with the corresponding *.suffix*.
- +i Produce intermediate *..c* C language file in the current directory.
- +L Generate source line number information using the format "#line %d" instead of "%d".
- +*xfile* Read a file of sizes and alignments. Each line contains three fields: a type name, the size (in bytes), and the alignment (in bytes). This option is useful for cross compilations and for porting the translator. See the *AT&T C++ Language System Release 2.0 Release Notes* for more information.
- +e[01] Optimize a program to use less space by ensuring that only one virtual table is generated per class. +e1 causes virtual tables to be external and defined, that is, initialized. +e0 causes virtual tables to be external but only declared, that is, uninitialized. When neither option is used, virtual tables will be static, that is, there will be one per file. Usually, +e1 is used to compile one file that includes class definitions, while +e0 is used on all the other files including those class definitions.
- +d Do not expand inline functions.
- +w Warn about all questionable constructs. Without the +w option, the translator issues warnings only about constructs that are almost certainly problems.
- +p Disallow all anachronistic constructs. Ordinarily the translator warns about anachronistic constructs; under +p (for "pure"), the translator will not compile code containing anachronistic constructs, such as "assignment to this." See the *AT&T C++ Language System Product Reference Manual* for a list of anachronisms.
- +a[01] The translator can generate either ANSI C style or "Classic C" (also known as K&R C) style declarations. The +a option specifies which style of declarations to produce. +a0, the default, causes the translator to produce "Classic C" style declarations. The +a1 option causes the translator to produce ANSI C style declarations.

See *ld*(1) for loader options, *as*(1) for assembler options, *cc*(1) for code generation options, and *cpp*(1) for preprocessor options.

## FILES

Most of the default pathnames listed below can be modified by changing environmental variables in CC.

file.[Cc]	input file
file..c	optional cfront output
file.o	object file
a.out	linked output
/lib/cpp	C preprocessor
cfront	C front end
/bin/cc	C compiler
/lib/libc.a	standard C library; see Section (3) in the <i>UNIX System V Programmer Reference Manual</i>
/lib/libC.a	standard C++ library
/lib/libtask.a	C++ real-time library
/lib/libcomplex.a	C++ complex library
/usr/include/CC	standard directory for #include files

## SEE ALSO

cc(1), monitor(3), prof(1), ld(1), cpp(1), as(1).

Bjarne Stroustrup, *The C++ Programming Language*, Addison-Wesley 1986.

B. W. Kernighan and D. M. Ritchie, *The C Programming Language*, Prentice-Hall 1978.

## DIAGNOSTICS

The diagnostics produced by CC itself are intended to be self-explanatory. Occasional messages may be produced by the assembler or loader. No messages should be produced by cc(1).

## BUGS

Some "used before set" warnings are wrong.

**NAME**

c++filt - C++ name demangler

**SYNOPSIS**

c++filt [-m] [-s] [-v]

**DESCRIPTION**

*C++filt* copies standard input to standard output after decoding tokens which look like C++ encoded symbols. Any combination of the following options may be used:

- m            Produce a symbol map on standard output. This map contains a list of the encoded names encountered and the corresponding decoded names. This output follows the filtered output.
- s            Produce a side-by-side decoding with each encoded symbol encountered in the input stream replaced by the decoded name followed by the original encoded name.
- v            Output a message giving information about the version of *c++filt* being used.

**SEE ALSO**

CC(1), ld(1), nm(1).

Bjarne Stroustrup, *The C++ Programming Language*, Addison-Wesley 1986.

**NAME**

elf\_demangle - decode a C++ encoded symbol name

**SYNOPSIS**

char \*elf\_demangle (char const \*symbol)

**DESCRIPTION**

*demangle* decodes an encoded C++ symbol name into a format which more closely resembles the original C++ declaration. This routine should be used to convert symbols obtained from an ELF symbol table into a form more suitable for output.

**WARNING**

This routine allocates space for the return buffer using the ELF allocation routines.

**CAVEAT**

The return value points to static data whose content is overwritten by each call.

**SEE ALSO**

CC(1), c++filt(1), libelf(3), nm(1).

Bjarne Stroustrup, *The C++ Programming Language*, Addison-Wesley 1986.

**DIAGNOSTICS**

The argument, *symbol*, will be returned if it points to a string which does not need decoding. A return value of NULL indicates that storage could not be allocated for the return buffer.



---

# Index

---

Index

I-1





---

# Index

## A

abstract classes 1: 2, 21–22  
access  
  adjusting 1: 6  
  rules for 7: 1–3  
access control 1: 2–8  
  syntax 1: 5  
ANSI-style C headers 6: 6  
arguments, varying numbers of 3: 3–4  
assignment 1: 2, 36–38, 3: 8–9, 4: 10–11  
assignment to **this** 1: 28–29

## B

base and member initialization 1: 2  
base classes (see *classes*)  
base members 7: 5

## C

C linkage 6: 8–9  
casting 5: 6–7, 11–12  
class libraries 2: 31–33  
classes 2: 3, 5, 7–8, 21–22, 3: 5–10, 4: 5–6, 9–17  
  base 1: 36, 3: 11, 5: 1, 10–11, 7: 1, 3  
  derived 1: 15–17, 20, 36, 2: 28, 3: 10, 12, 5: 3, 7:  
    1  
  implementation of 2: 5–6, 15  
  multiple base 5: 4  
  private base 1: 6  
  specification of 2: 7  
  virtual base 1: 14, 16, 20, 5: 12–14, 17  
coercions 3: 2, 9–10, 4: 14–15  
complex arithmetic library 2: 26  
const member functions 1: 2, 23–24  
const specifier 1: 44–45  
constants 2: 16, 3: 3  
constructors 2: 11–12, 15–18, 20–21, 3: 6, 8, 4:  
  9–11, 5: 12, 15–16  
  and initialization 2: 12  
  and type conversion 2: 12

## D

data abstraction 2: 4–5, 26, 3: 5–10, 4: 1, 5–6,  
  16–17, 24  
problems with 4: 7–8

  support for 4: 9–16  
data access 7: 1–12  
data hiding 1: 3, 2: 8, 3: 13–14, 4: 3, 5, 11  
deallocation, controlling 1: 32  
declarations  
  as statements 3: 4  
  syntax for 1: 42–43  
delete operator 1: 1, 28–29, 32–35, 3: 6–7  
  size argument to 1: 35  
derived classes (see *classes*)  
destructors 2: 13, 23, 3: 6, 4: 9–10, 5: 15–16  
  explicit calls of 1: 35  
  virtual 1: 20  
directed acyclic graphs 1: 14–16  
dynamic character strings 2: 26

## E

encapsulation 4: 21–22  
enumerators 1: 43–44  
error handling 4: 13–14  
evolution of C++ 1: 1–49  
example of C++ 2: 3–25  
exception handling 4: 13–14  
expressions, syntax for 1: 42–43  
extern “C” syntax 6: 1–23

## F

free store management  
  class-specific 1: 29  
  user-defined 1: 2, 28–36  
friend functions 1: 3, 5, 7, 2: 22, 3: 5  
friends 7: 1  
function declaration syntax 1: 47  
function types 1: 45  
functions  
  argument syntax for 1: 41  
  calls to member 2: 11, 4: 17–18, 5: 5  
  member 2: 9, 23, 4: 17, 21  
  signature of 6: 1, 5–7  
  virtual 1: 15–16, 18, 21–22, 2: 28–31, 3: 12–13,  
    4: 8, 17, 19, 5: 3–4, 8, 14–15

## I

inheritance 4: 19–20, 7: 1

multiple 4: 20–21, 5: 1–20  
initialization 1: 2, 36–38, 3: 8–9, 4: 9–11  
  of bases and members 1: 18–20  
  of static members 1: 2, 24–25  
  of static objects 1: 3  
initialization and cleanup 3: 6  
inline functions 2: 24–25, 3: 3, 4: 17  
introduction to C++ 2: 1–38  
iostream library 2: 26–27  
iterators 4: 15–16

## L

libraries 1: 1, 22, 4: 16  
linkage  
  type-safe 6: 1–23  
  upgrading existing C++ programs for 6: 12  
lvalues 1: 45

## M

member functions (see *functions*)  
memory, allocation and deallocation 4: 9–10  
memory exhaustion 1: 35  
modules 4: 3, 6  
multiple inheritance 1: 2, 14–18, 4: 20–21, 5:  
  1–20  
  ambiguities in 5: 9–10

## N

name spaces, multiple 1: 46–47  
new operator 1: 1, 28–32, 34, 2: 16–17, 3: 6–7  
new() operator, inheritance of 1: 30

## O

object I/O 2: 33–35  
object-oriented programming 2: 28, 3: 10–14, 4:  
  1–25  
  implementation of 4: 23  
  support for 4: 17–23  
objects, layout of 5: 4–5  
operator new(), overloading 1: 31  
operators  
  addition (+) 2: 19  
  comma (,) 1: 3, 40  
  delete 1: 1, 28–29, 32–35

member of (>) 1: 3, 39–40  
new 1: 1, 28–32, 34  
scope resolution (::) 1: 34, 2: 16  
sizeof 1: 29, 49  
overload keyword 6: 1, 5  
overloading  
  of functions 2: 10, 3: 4, 6: 1–2  
  of operators 2: 12–13, 3: 9, 4: 9  
  of > operator 1: 1  
overloading resolution 1: 2, 8–11  
overview of C++ 3: 1–16

## P

pointers, with zero value 5: 7–8  
pointers to members 1: 1–2, 25–27  
private base classes (see *classes*)  
private keyword 5: 17  
private members 7: 1, 4  
procedural programming 4: 2–3  
protected members 1: 1, 3–5, 3: 13, 7: 1, 4  
protection 3: 13–14, 7: 1–12  
public base classes 7: 1  
public keyword 2: 8, 5: 17  
public members 7: 1, 4

## R

references 2: 18–19, 3: 7

## S

scope resolution (::) operator 1: 34  
scoping 6: 15  
sizeof operator 1: 29, 49  
static member functions 1: 2  
static member functions 1: 22–23  
static members, initialization of 1: 24–25  
static objects, initialization of 1: 41

## T

this pointers 2: 23, 5: 5, 8  
type checking 4: 18–19, 6: 5  
  of arguments 3: 2  
  of function arguments 2: 10  
types  
  parameterized 4: 12–13, 16

user defined 2: 3, 5, 7-8, 21-22, 3: 5-10, 4:  
5-6, 9-17  
type-safe linkage 1: 2, 11-13

## V

variables

of user defined types 4: 5  
references to member 2: 16

vectors 2: 26

virtual base classes (see *classes*)

virtual functions (see *functions*)

